

EX86012 Electric Power CRAWLER





Specifications:

LENGTH	WIDTH	HEIGHT	WHEEL BASE	DIAMETER OF WHEEL	WIDTH OF WHEEL	Gear Ratio	SERVO	WEIGHT
345mm	190mm	180mm	235mm	105mm	40mm	1:88	2.5kg	1150g

Spare Part

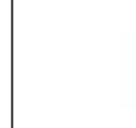
68066-F/R Gear Box  Old:68001	68067-Caster Mounts (L/R)  Old:68004	68068-Steering Mounts  Old:68005	68170 - Rear Axle Cover Bushing 
68057-Servo Plate W/ Servo Mount  Old:68007	68153 - Diff. Gears Set 	68125 - Skid Plate 	68026-Battery Holder w/ Cover 
68018-Body Post 	68270-Servo Linkage 	68273-Side Linkage 	68274-Center Linkage 
68019-Connect Linkage 	68012-Universal Driven Dogbone 	68053-Shock Absorber 	68190 - Complete Transmission Set 
68136 - Wheel Tire 1 (Grey) 	68137 - Tire With Memory Foam 	68138 - Pre-Mounted Tire Set type 1 (Grey) 	68275-Side Guard 

Spare Part

68009-Connect Box W/Main Gear(38T) 	68010-Drive Gear 	68054-Motor Gear (14T) 	68184 - V2 390 Size Aluminum Motor Mount 
68011-Drive shaft 	68017-Dogbone 	68246 - Rear Drive Shaft 	68104-Wheel Axle 
68105-Wheel Hex. W/ Pins (2*10) 	68028-Ball Stand Φ4.0 	68029-Ball Stand Φ 4.0 	18033-Ball Bearings (5*10*4) 
68032-Ball Bearings (7*11*3) 	68033-Ball Bearings (4*8*3) 	82832-Body Clip 	02055-Nylon Nuts M4 
98055-Nylon Nuts M3 	68035-E-Clips Φ 3.2 	18039-Grub screw M3*3 4P 	18051-Grub Screw M3*15 6P 
68046-Countersunk Head Machine Screw M2*6 8P 	68047-Countersunk Head Machine Screw M2*8 8P 	68141 - Countersunk Screw M2*12 	68142 - Countersunk Screw M2*15 



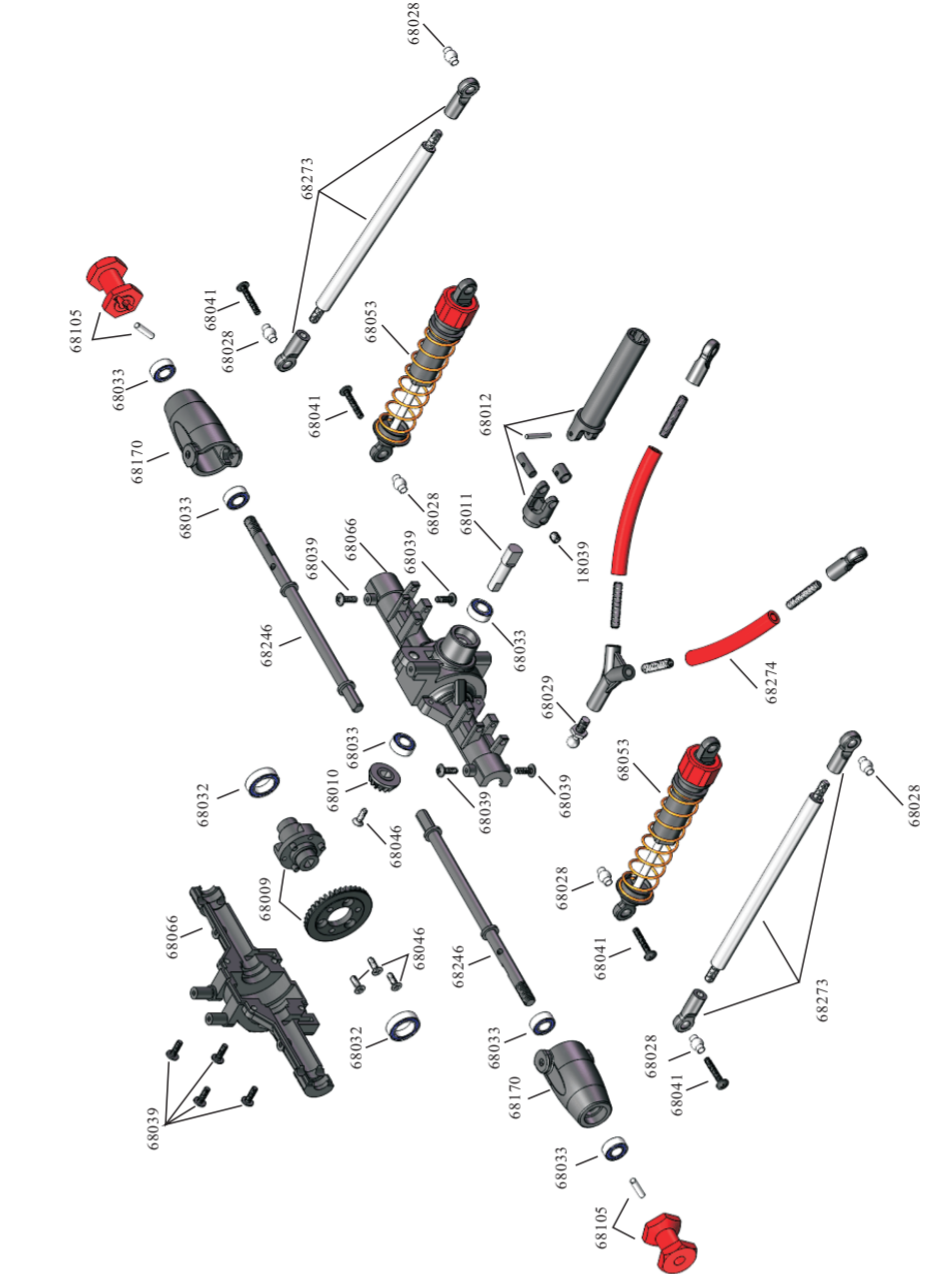



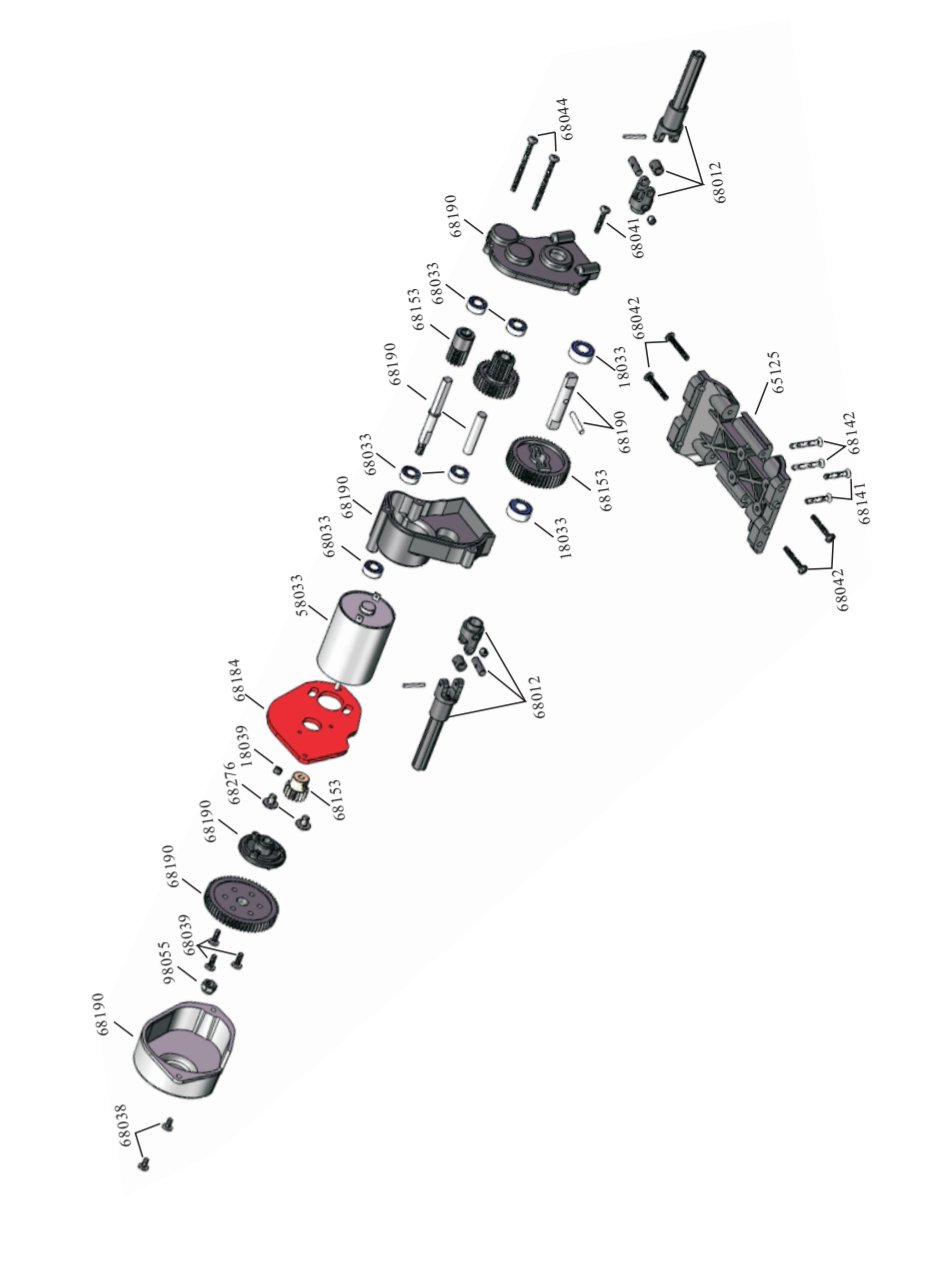



Front Drive System Assemble









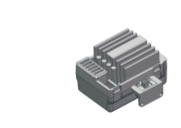
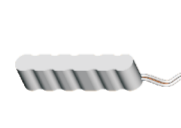
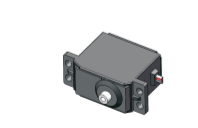

Center Transmission Assemble

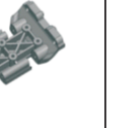

Spare Part

68038-Cap Head Machine Screw M2*4 8P 	68039-Cap Head Machine Screw M2*6 8P 	68040-Cap Head Machine Screw M2*8 8P 	68041-Cap Head Machine Screw M2*12 4P 
68042-Cap Head Machine Screw M2*14 4P 	68043-Cap Head Machine Screw M2*20 4P 	68044-Cap Head Machine Screw M2*27 4P 	68276-Cap Head Machine Screw M3*4 8P 
98068-Cap Head Machine Screw M3*8 8P 	58033-Motor (Rc370) 	68064 - ESC 	28003-Normal Battery Pack (7.2V 1100mAh) 
68250- Servo 2.5KG 			

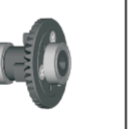
Upgradable Optional

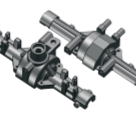
680001-Gear Box (Shell only) (AL.) 	680002-Steering Mounts (AL.) 	680038-Caster Mounts (L/R) (AL.)  Old:680003	680027 - Skid Plate (AL.) 	680040 - Rear Axle Cover Bushing (AL.) 
680008-Shock Absorber (AL.) 	680009-Body Post (AL.) 	680010-Connect Box (W/Gear 38T)(AL.) 	680021-Servo Mount (AL.) 	680012-Universal Driven Dogbone(AL.) 
680039-F/R Gear Box (AL.)  Old:680015				

Wheels

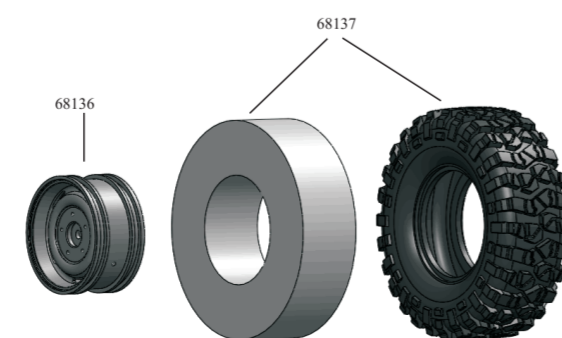

Rear Drive System Assemble

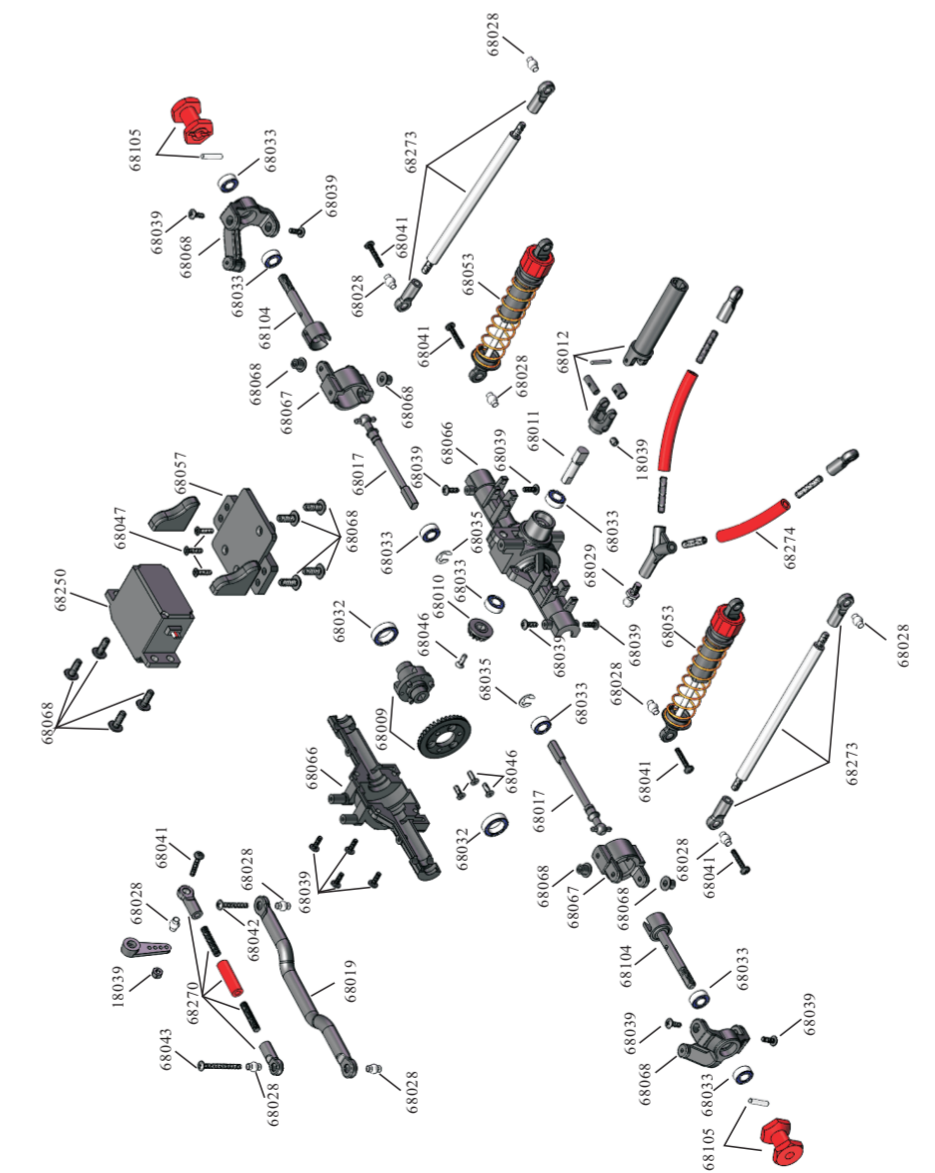

Rear Component Assemble

