

RCGF35CCRE Operator's Manual

(note: the spare parts list and dimension of engine are in the end of manual)



RCGF 35cc

Parameter:

Type : 2 cycle piston valve type gasoline engine for airplane

Piston displacement Cylinder (cc) : 35cc (2.13 cu in)

Bore x Stroke (mm): 1.53 in(39mm) x 1.18 in (30mm)

Carburetor : RCGF

Ignition : DC-CDI (Computer Controlled auto advance, electronic ignition system)

Power supply: 4.8-8.4V

Maximum Output :4.1HP@9000

Requires: Gasoline, 2-cycle oil, ignition battery & propeller

speed rang : 1500-9000rpm

Gasoline-Version : Pre-mixed Fuel, 25-40 (Gasoline):1 , Recommend:30:1

(90% high octane unleaded gasoline, Import gas into carbon fiber installations valves)

Lubrication Oil : 2 cycle engine oil

Propeller : 19X8 7900rpm (Standard Two leafs prop)

Suggested Propellers: 19x8 & 20x8,20X10

Suggested Break-in Prop: 19x8

Sparking plug: NGK CM6 Type

Cooling System : Air Cooled

RCGF engine package Includes: electronic CDI ignition, muffler, spark plug, gaskets, bolts, stand off,throttle arm extension & manual.

Weight :

Engine: 2.03 lb (923 g)

Muffler: 3.4 oz (97 g)

Ignition Module: 4.4 oz (125 g)

Total: Weight: 2.52 lb (1145 g)

Technical Data:

Ignition Battery: 4.8-8.4 NiCd or NiMH, 6.6V LiFe or 2S LiPo pack

Gasoline/Oil Mix: 30:1

Replacement Spark Plug: NGK CM6 or equivalent

Idle Speed: 1800 rpm/min

Static Thrust:

19.9 lb (9 kg) @ 328 ft (100 m) altitude

19.0 lb (8.6kg) @ 5,900 ft (1800 m) altitude



SPARE PARTS LIST

- (1) 1pc RCGF-35cc Gas Engine
- (2) 1pc RCGF Spark Plug (NGK CM6 size)
- (3) 1pc Muffler with gasket and bolts (5X16 mm)
- (4) 4pcs stand offs
- (5) 8pcs 5 x 20 mm bolts
- (6) 1pc Electronic Ignition Module with additional tachometer lead
- (7) Long Throttle Arm Extension
- (8) RCGF Decal

Safety Tips and Warnings

- This engine is not a toy. Please place your safety and the safety of others paramount while operating. RCGF will not be responsible for any safety issues or accidents involving this engine.
- Operate the engine in a properly ventilated area.
- Before starting the engine, please make sure all components including the propeller and the engine mount are secure and tight. It is strongly recommended that a good quality screw sealant is used during engine installation.
- During the break-in period, it is recommended that the engine be installed on the aircraft or a test stand with an appropriate shock absorber. Otherwise it is probable that vibration could rebound back to the engine and serious damages may occur during the break-in period.
- For your safety and the safety of others, please do not stand in front or in line with the propeller when the engine is running. Keep onlookers away from the running engine, especially small children.
- Always use a balanced spinner and a balanced propeller. An unbalanced spinner and propeller combination will cause high levels of vibration and may cause the propeller shaft to break. Always use a lightweight spinner on your engine. Lightweight spinners are considered to be those with a cone wall of 1mm or less. Heavy spinners could cause the propeller shaft to break. Securely tighten the spinner and propeller on the engine to prevent it from being thrown off the engine while running.
- Never use a propeller that has hit the ground. Even though it may look good from the outside, it may be cracked on the inside which may cause it to disintegrate while in use. Do not use a nicked, cracked or split propeller.
- Keep foreign objects away from the propeller. Make sure that nothing can be “sucked in” by the propeller.
- Never start the engine on loose gravel or sand.
- Do not attempt to stop the engine by throwing anything into the path of the propeller.
- Make sure the fuel line is well-secured to the engine and to the fuel tank so that it won't come off in flight.
- Do not use silicone fuel line because it will be dissolved by the fuel. Use gasoline approved vinyl or neoprene rubber fuel line. Always secure the fuel line away from the cylinder. The engine's heat can damage the fuel line.
- Never touch the engine immediately after a run. The engine will be hot.
- Before transporting your model, remove all the fuel from the fuel tank and fuel lines.
- Always use high-quality oil intended for 2-stroke (2-cycle) engines. It's a good idea to use a petroleum based 2-cycle motor oil like Lawn Boy All Season – Ashless, Generation II oil for the break-in period. Break-in should be considered about the first 3-5 gallons you run the engine. A high quality synthetic 2-cycle oil is recommended for optimum performance and a longer engine life. Synthetic 2-cycle oils leave fewer combustion byproducts than natural oil which can foul the engine and exhaust ports, resulting in reduced performance. Synthetic oils also reduce friction and provide more fluidity at low temperatures.

- Do not install your throttle servo or kill switch servo inside the engine compartment. Doing so could cause radio interference. Install all electronic radio devices as far away from the engine as possible.
- The throttle and choke pushrods should be non-metallic.
- If the engine is not to be used for more than a month, drain the fuel tank and remove any fuel from inside the carburetor. Do this by running the engine at idle until it quits by running out of fuel. Keeping gasoline inside the carburetor over an extended period of time will damage the diaphragm valve and clog passages inside the carburetor. Due to the carburetor being more complicated than those used in glow engines, keep the fuel clean by using a fuel filter. Use a filter intended to be used with gasoline engines. Metal filters intended for glow engine are too coarse and will not screen out finer particles.
- Always filter your fuel by using an appropriate filter before putting it into the airplane's fuel tank.
- Gasoline is extremely flammable. Keep it away from an open flame, excessive heat or sources of sparks.
- Do not smoke near the engine or the fuel tank.
- This engine was designed for use in a model aircraft. Do not attempt to use it for any other purpose.
- Always install an ignition system kill switch on the aircraft used.
- Do not install your throttle servo or kill switch servo inside the engine compartment. Doing so could cause radio interference. Install all electronic radio devices at least 12" [305mm] away from the engine.
- Caution: Running the engine with a lean gas mixture will cause the engine to overheat and burn the electrode of the spark plug. Pay close attention to the High-speed Needle adjustment. Running the engine with the proper gas mixture will cause the spark plugs to appear yellow at the ignition point.
- For optimum performance please use fresh or recently purchased 93 octane gasoline (87 octane gasoline will suffice) with a 30:1 gas/oil mixture.

GAS/OIL Mixing Chart

1 Gallon Gasoline (128 fl oz/3.78L) / 2-Cycle Oil

(4.26fl oz/125.68ml) = 30:1 ratio

- Excessive running of the engine at idle speed can result in a seriously carbonized spark plug.
- Keep the surface of the engine clean to ensure proper heat dissipation. Ensure proper cooling/ventilation around the cylinder with adequate air exhaust.
- To avoid permanent damage to the electronic ignition system, never rotate the propeller on your RCGF engine with the electronic ignition system switched on and the plug not installed in the plug cap.

Installation Instructions

Prepare the engine for installation

Before beginning installation it's a good idea to plan location of the various components of the engine. Many of the following steps may need to be completed in a different order than listed.

1. Check to see that all screws and bolts are tight. Check carefully for any cracks, broken, or missing parts. Tighten or replace any damaged or missing parts before proceeding.

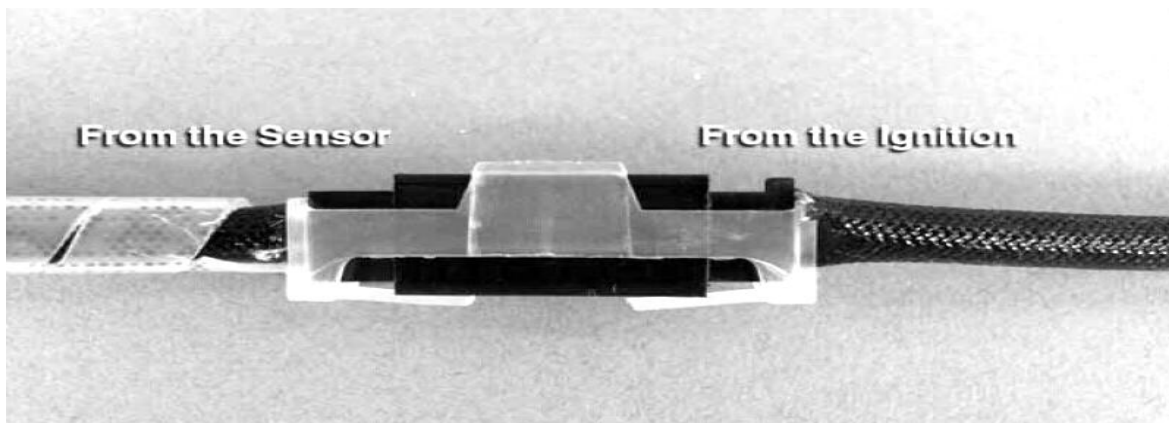
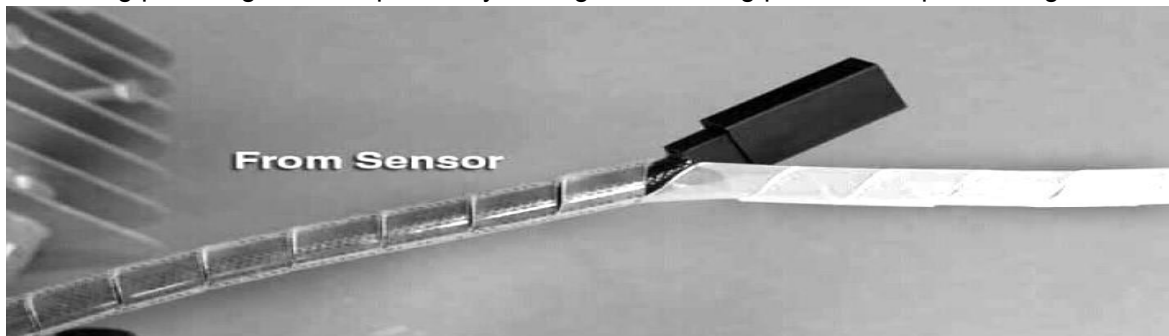

2. Install the silicone wire cover over the pick up lead coming from the engine (cut the excess silicon wire cover) and connect the lead to the pick-up lead from the Electronic Ignition Module. Secure the connection with the included three pin connector securing clip.

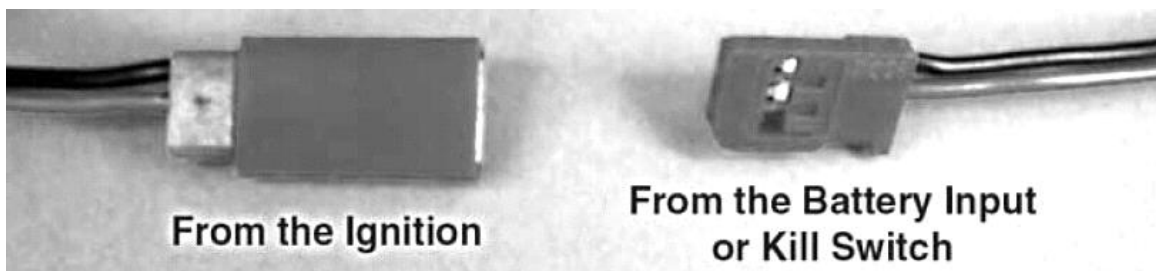

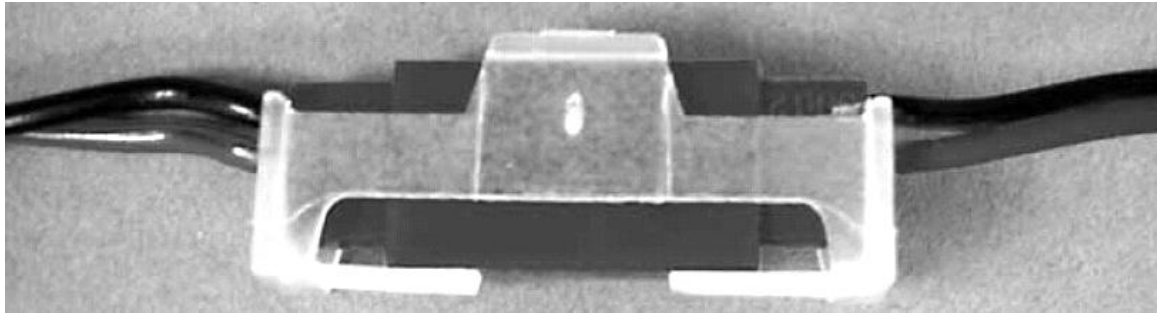

3. Connect the kill switch lead to the red connector from the ignition control module using the lead from the kill switch or with the included three pin connector with pig tail. Use one of the included three pin securing clips to secure the connection.

4. Connect the ignition module battery to the kill switch. Any 4.8-6.0V, 1000mAh and above capacity battery will work well for this. Use heat shrink tubing to secure this connection.

5. Install the ignition kill switch and charge jack on the aircraft so that it is easily accessible from the outside of the plane.

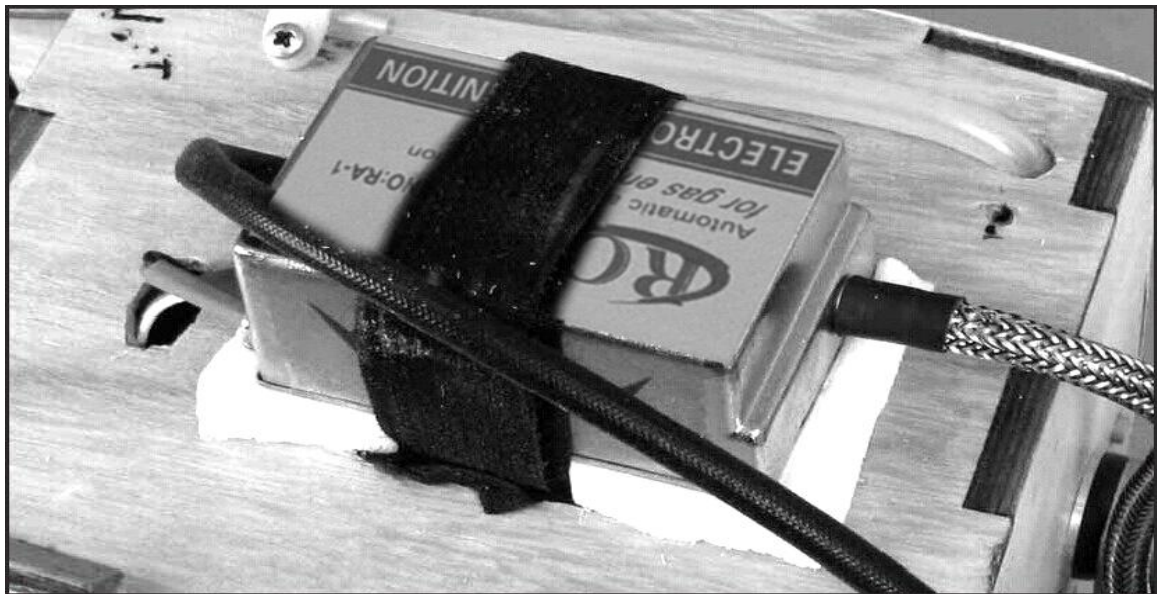

6. Install the ignition module securely in the airplane forward area. It is recommended that a thin piece of foam rubber is placed between the module and the mounting surface and that Velcro ® is used to hold the module in place.

7. Secure all connections with heat shrink tubing (not supplied)

8. Install the silicone ignition wire cover over the ignition wire to the spark



plug.

9. Install the spark plug into the engine cylinder (7-8lbs torque).

Installing the RCGF 35cc on Your Airplane

Note: The RCGF 35CC must be installed on at least a 9.5mm [3/8"] firewall.

The firewall must be securely glued to the airplane. Use triangle stock and pin the firewall with hardwood dowels to reinforce the firewall glue joints. Never install the RCGF 35cc onto a firewall thinner than specified because it may fail due to the power of the engine.

Note: The length of the engine from the back on the engine mount to the face of the propeller washer is 6.34" [161mm].

1. Please check engine size chart (on the back cover of this manual) to drill the engine mounting bolt holes.
2. Install the standoffs to the engine with the included 5 x 20mm SHCS and 5mm flat washers (it's a good idea to use 5mm lock washers between the SHCS and the flat washers). Next, install the engine with standoffs to the firewall using 5 x 20mm SHCS with 5mm lock washers and flat washers . Use threadlocking compound on all mounting screws.
3. Install the fuel tank in the airframe. Use only gasoline approved fuel tank and fuel lines and a gasoline approved stopper. One line should go to the carburetor and the other is to be used as a vent (a vent line is simply an open ended fuel line from the fuel tank which exits the engine compartment or the fuselage; most vent lines exit at the bottom of the firewall). You can fill the tank by using the carburetor line as fill line if you have access to it or install a third line to be used as fill line. Installing a third line is the cleanest and easiest way to add fuel. An alternative fueling set up is a 2-line system with a T-fitting approved for gasoline use. Be sure to use a filler plug with either a 2 line or 3 line set-up. It's a good idea to add an extension to the vent line as shown, that goes up and to the rear of the tank. This helps to avoid draining fuel from the tank when the model is pointed down.

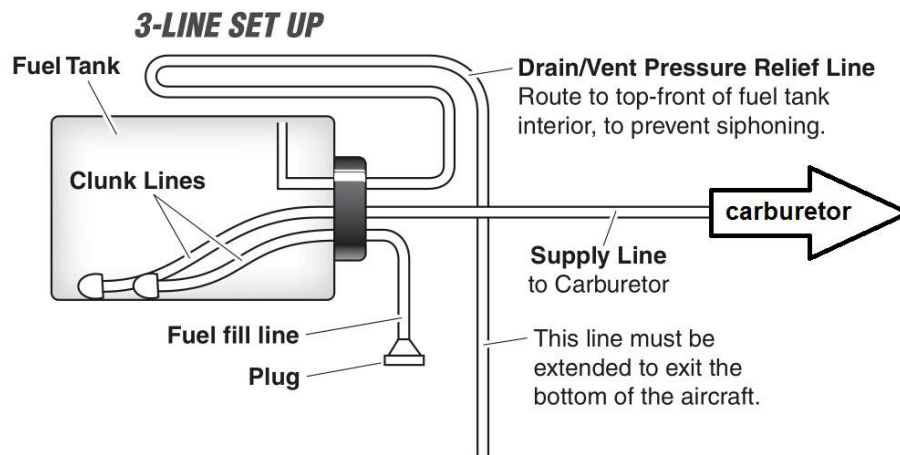
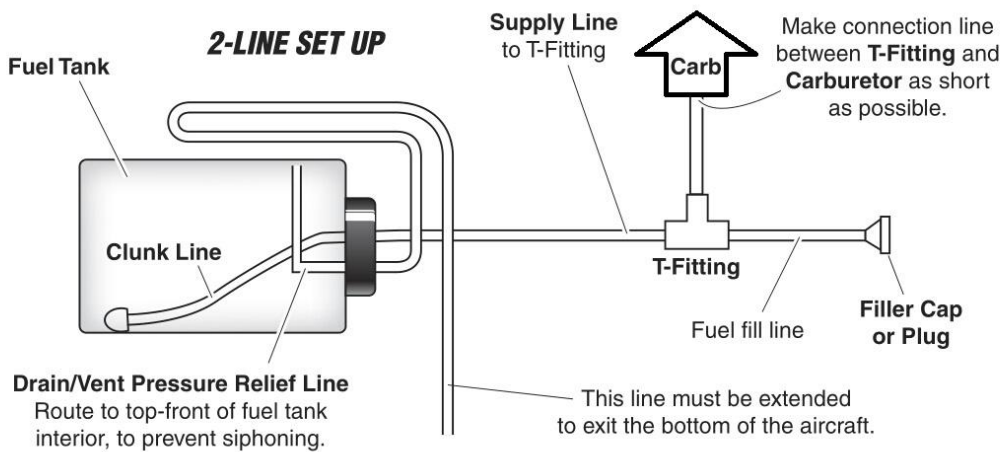

4. Install the throttle servo at least 12" [305mm] away from the engine. Make sure that you get the carburetor's full range of rotation with your servo travel. Be sure to use a non-metallic linkage.
5. Install the choke servo (optional) at least 12" [305mm] away from the engine. Be sure to use a non-metallic linkage.

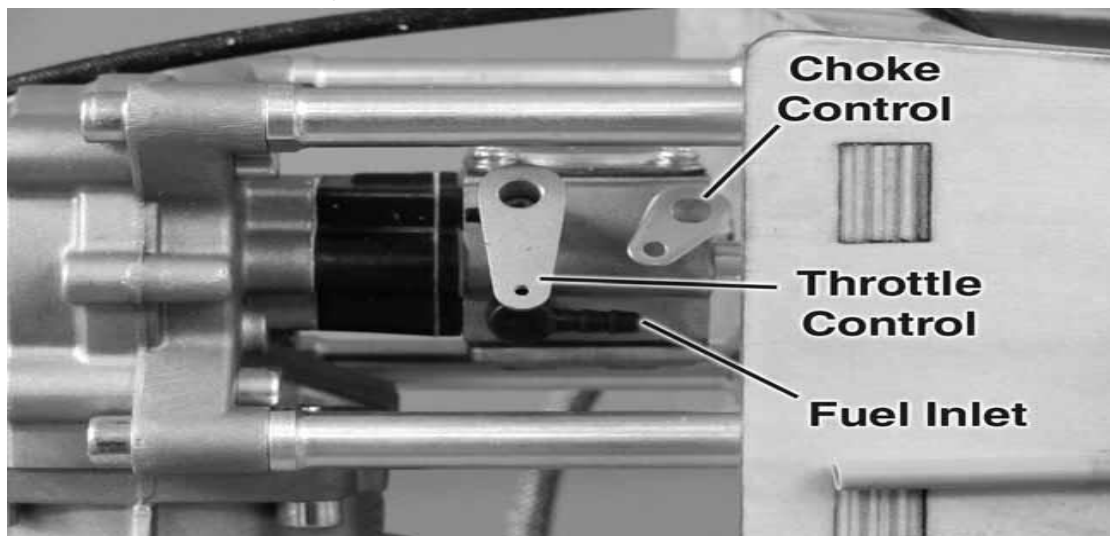

6. Connect the ignition wire from ignition module to the spark plug.

7. Install the muffler onto the engine. Be sure to use threadlocker and that the ignition wire does not contact the muffler.
8. Cut all necessary clearance, carburetor adjustment, cooling, and exhaust holes in the cowl.
9. Make sure the cowl is secured to the airplane and that the knurled thrust washer protrudes from the cowl by at least 3.2mm [1/8"].

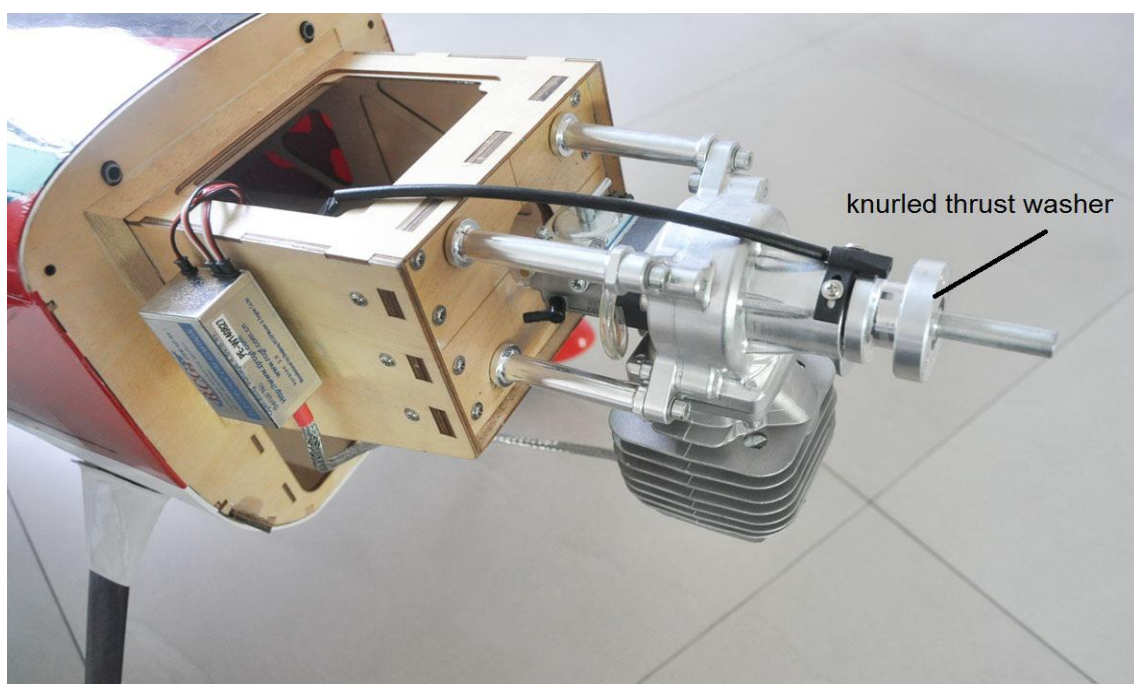
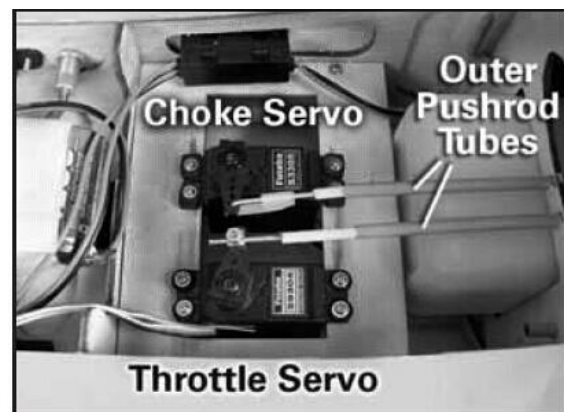
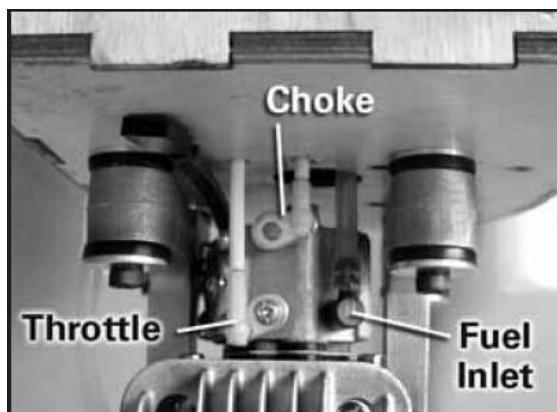
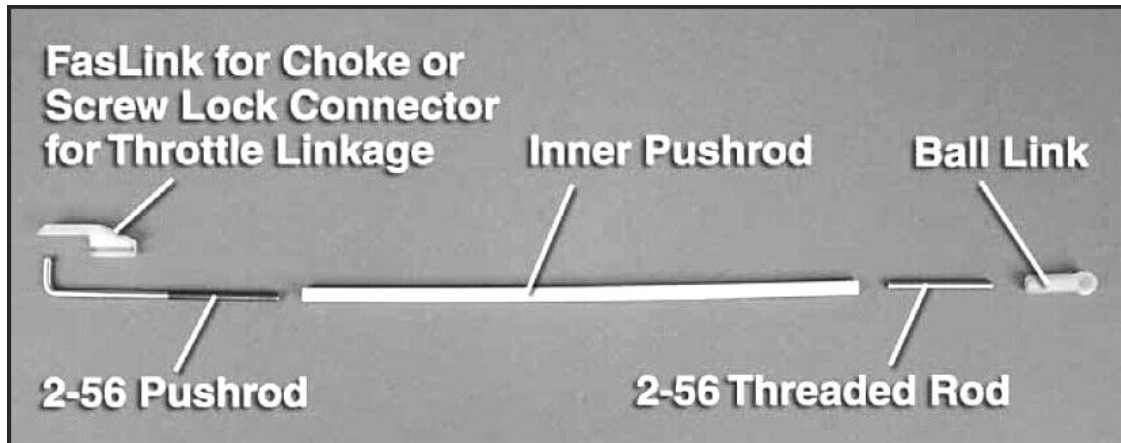

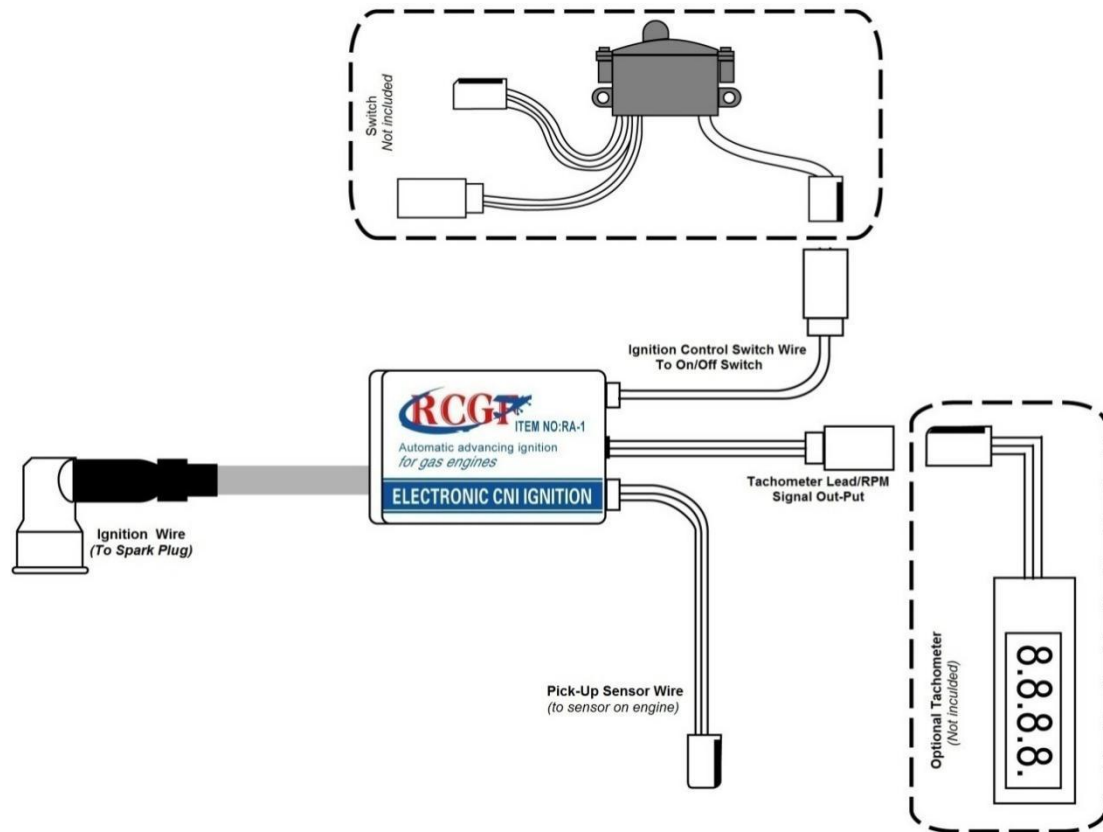

Drill and Install the Propeller

The easiest way to drill the propeller to fit the hub is to use a drill guide. If you do not have a drill guide, you can use the following method to drill your propeller. Most propellers within the recommended size range have a 0.393" [10mm] center hole pre-drilled. If your propeller has this predrilled hole, move on to step 3. If not, start with step 1.

1. Remove the cowling from the aircraft. Use the included propeller washer to mark the centering hole on the propeller



2. Once the location is established, use a drill press with a 10mm drill bit. In order to achieve a clean hole opening on both sides of the propeller, drill only half way through the propeller with the 10mm drill bit. Then flip the propeller over and drill completely through the hole.

3. Next, set the engine at the top of the compression stroke. Note the position of the ignition magnet with engine inverted.

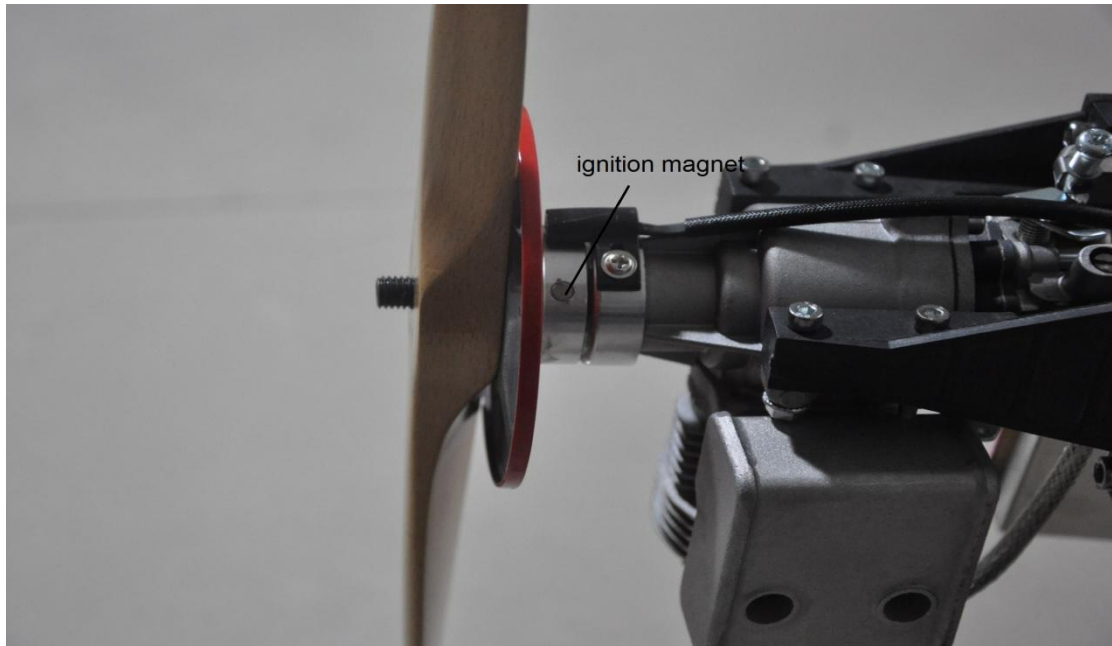

4. Place the propeller on the crankshaft at the one o'clock position.

5. Mark the location of one of the outer holes while the propeller is in the beginning of the compression stroke position. Use a Dead Center Hole Locator to center and start the hole.

6. Remove the propeller from the engine and drill the outer hole on the drill press using a (.110"/ 2.81mm) drill bit as a pilot hole. Next use a (.157"/ 4.01mm) drill bit to finish the hole. In order to achieve a clean finish on both sides of the propeller, drill only half way through the propeller with the finishing drill bit. Then flip the propeller over and drill completely through the hole.

7. Use one of the 4x35mm SHCS with 4mm lock washers and flat washers to align the propeller washer on the propeller and use the Dead Center Hole Locator to mark the position of the remaining holes.



8. Drill the remaining three holes in the propeller using the same technique as step 6.
9. Mount the propeller to the engine using the 4x35mm SHCS with 4mm lock washers and flat washers. Be sure to use thread locker.

Adjustment of the Engine

Each RCGF Engine has been factory preset. However, differences in elevation will influence the performance of the carburetor. To obtain optimum output of the engine, slight adjustment of the carburetor may be necessary

Engine Functions and Adjustments

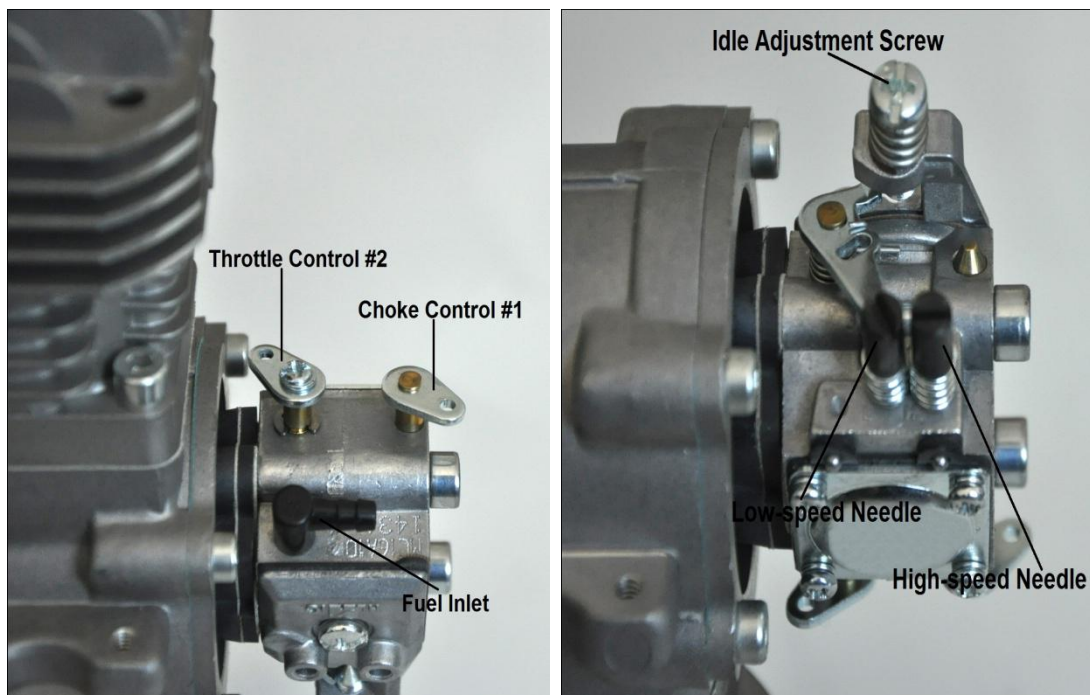

1. Choke Control (the choke control should be used when the engine is cold)
2. Throttle
3. Idle Adjustment Screw (adjust the idle speed)
4. (L) Low-speed Needle (adjusts the fuel/air mixture at low speeds)
5. (H) High-speed Needle (adjusts the fuel/air mixture at high speeds)

Idle Adjustment

Turning the Idle Adjustment Screw clockwise will increase the idle speed. Turning the Idle Screw counter-clockwise will decrease the idle speed.

Low Speed Needle Adjustment

Turning the Low-speed Needle clockwise will lean the fuel/air mixture at low speeds. Turning the Low-speed Needle counter-clockwise will richen the fuel/air mixture at low speeds. (The default or factory setting of the Low-speed Needle is as follows: turn the

needle to the fully stop/closed position and then turn back 1.5 turn.)

High Speed Needle Adjustment

Turning the High-speed Needle clockwise will lean the fuel/ air mixture at high speeds. Turning the low-speed Needle counter-clockwise will richen the fuel/air mixture at high speeds. (The default or factory setting of the High-speed Needle is as follows: turn the needle to the fully stop/closed position and then open the needle 2 turns). It is recommended that the High-speed needle be adjusted by the use of a tachometer to obtain maximum speed. Smooth acceleration and deceleration is an indicator of proper engine performance.

Ignition Timing Adjustment

The ignition timing is preset on the RCGF35cc at 28-30° before Top Dead Center (TDC). The ignition timing can be advanced or retarded by loosening the ignition sensor Phillips head screws and sliding the sensor to the full extent clockwise (32° advancing the ignition) or counter clockwise (26° retarding the ignition). Be sure to retighten the Phillips head screws after adjusting the ignition timing. It is best to attach the sensor with the screws centered in the slot as a starting point.

Advancing the timing causes combustion to occur earlier resulting in higher performance of the engine. However, advancing the timing also causes higher engine temperatures and can cause premature wear of internal engine components.

Carburetor Adjustment Troubleshooting

Problem:

If The engine hesitates when accelerated rapidly.or The rpm increases at idling. or The engine stops when the throttle is moved from high to low.

Solution:

The low-speed needle "L " is too lean. Open it up about 1/8 of a turn and try again.

Problem:

If The idle is not steady.

Solution:

The low-speed needle "L " valve is too rich. Close it 1/8 of a turn and try again.

Problem:

If Engine stops at full throttle.

Or Engine hesitates when accelerated rapidly.

Or The engine will not come up to full rpm at full throttle.

Solution:

The high-speed needle valve "H" is too lean. Open it up 1/8 of a turn and try again.

Problem:

If Your engine does not reach full rpm.
Or Carbon build-ups appear consistently on your spark plug.

Solution:

The high-speed needle valve "H" is too rich. Close it up 1/8 turn and try again.

Starting Procedures

When starting the engine the first time and during break-in it's recommended that you run the engine without the cowling. Also, for safety reasons do not adjust the carburetor while the engine is running. There are two recommended ways to start the RCGF 35cc:

A. Manual Starting

Note: When hand starting the RCGF 35cc, use a thick glove or heavy duty starter stick to protect your hand.

1. The propeller should be installed on the drive washer at the one o'clock position and at the beginning of the compression stroke so that it's comfortable to flip it through compression.
2. Have someone help you hold the airplane while you start the engine.
3. Switch the ignition to ON, close the choke on the carburetor and open the throttle slightly from the idle position.
4. Flip the propeller counter clockwise several times briskly, until a popping sound is heard. This indicates that the engine is firing.
5. Move the choke lever to the OPEN position.
6. Set the throttle to a high idle. Set the propeller so that it is at the beginning of the compression stroke.
7. Flip the propeller through compression rapidly. If this is done properly, the engine will start after several brisk flips of the propeller.
8. After starting, let the engine idle for 30 to 45 seconds. Open and close the throttle slowly until the engine runs smoothly at idle and at full throttle. Acceleration should also be smooth. If acceleration is not smooth, adjustments to the carburetor may be necessary (see Adjustment of the Engine.)
9. If your engine does not start, repeat steps 2-8.

B. Electric Starter Starting

A 12V electric starter is recommended to start the RCGF35cc

1. Make sure you use a good quality, lightweight aluminum spinner.
2. Have someone help you hold the airplane while you start it.

3. Switch the ignition to ON, close the choke plate on the carburetor and open the throttle slightly from the idle position.
4. Use your electric starter to turn the engine over for several seconds, until a popping sound is heard. This indicates that the engine is firing.
5. Move the choke lever to the open position.
6. Set the throttle to high idle and use your electric starter to turn over the engine until it starts.
7. After starting, let the engine idle for 30 to 45 seconds. Open and close the throttle slowly until the engine runs smoothly at idle and at full throttle. Acceleration should also be smooth. If acceleration is not smooth, adjustments to the carburetor may be necessary (see Adjustment of the Engine).
8. If your engine does not start, repeat steps 2-7.

Engine Troubleshooting

If your engine fails to start after the preceding starting procedures please check the following.

Symptom	Diagnosis	Fix
Engine does not fire	Ignition battery voltage low	Charge or replace battery
	Battery wires faulty or loose	Replace wires or Re-connect/check connections
	Faulty spark plug or not firing	Replace spark plug or check for spark
	Engine flooded	Remove plug, disconnect fuel line, rotate prop to remove fuel
Engine starts, then rpm increases till engine cuts out	Fuel not reaching engine	Check for: a) fuel in tank b) fuel tubing cut, blocked, or kinked c) carburetor clogged

This can be done by removing the spark plug from the cylinder and attaching the plug on the outside of the crankcase. Have an assistant turn the engine over while checking this and be sure to have the spark plug firmly plugged into the ignition wire.

Warning: The high voltage from the ignition can cause bodily harm, especially when checking for spark in this manner.

Optional Digital Tachometer (not included)

An optional Digital Tachometer is available that can be directly connected to the ignition and display the RPM of the engine. The Futaba ® DSC Charge Adapter can be mounted in the fuselage and allows easy external plug-in of the Digital Tachometer.



Many of the RCGF 8.4 V Ignition modules have an additional lead to plug into the Digital Tachometer. If your 6.V old ignition module does not have this additional lead, the Digital Tachometer can still be used. Simply use the Y-harness (included with the Digital Tachometer) to connect to the pick-up lead from the engine. Be sure to secure all connections and to secure the Digital Tachometer or leads on the aircraft used.

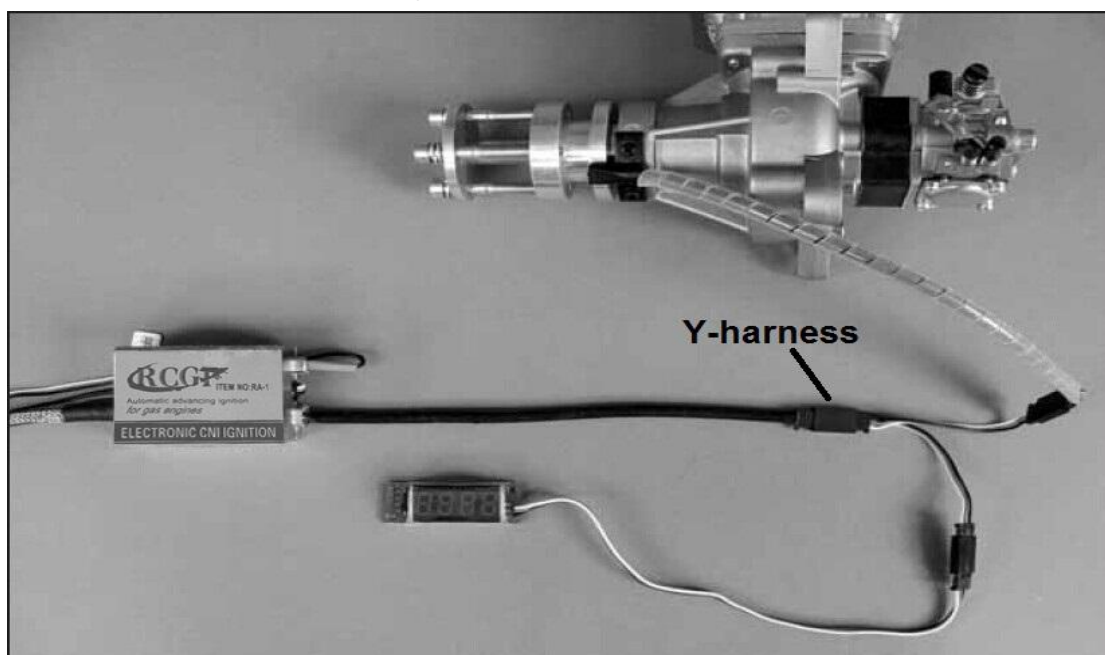

RCGF 8.4 V Ignition modules use the Digital Tachometer

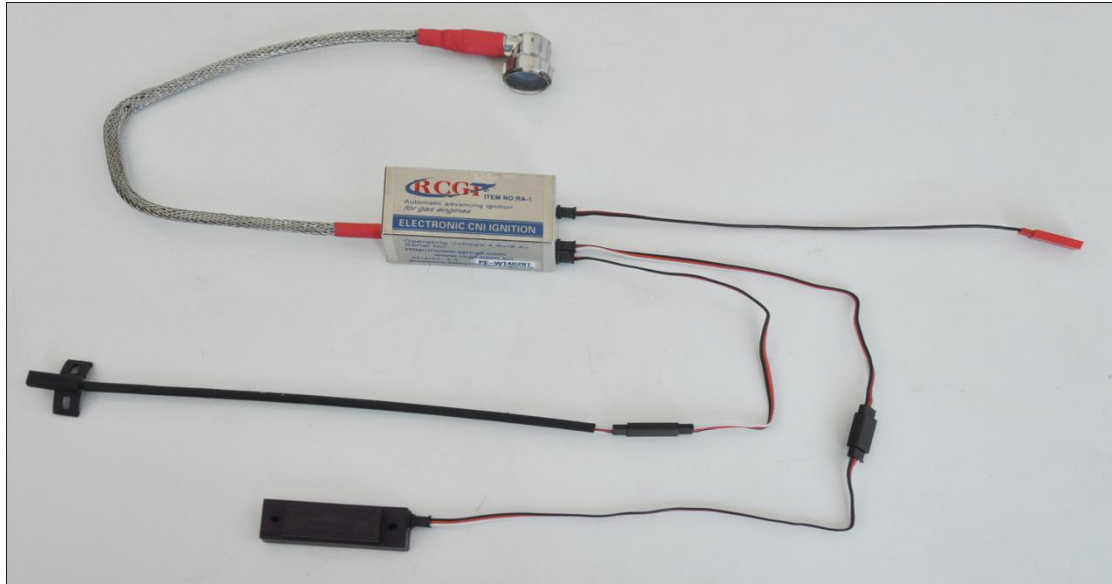

Engine Maintenance

Please clean the fuel filter in the RCGF Carburetor periodically. Failure to do so may result in miss-calibration of the needle adjustments. In order to do this it is necessary to remove the Phillips head screw which secures the carburetor filter cover and the carburetor filter gasket. Use only carburetor cleaner to clean the opening around the filter



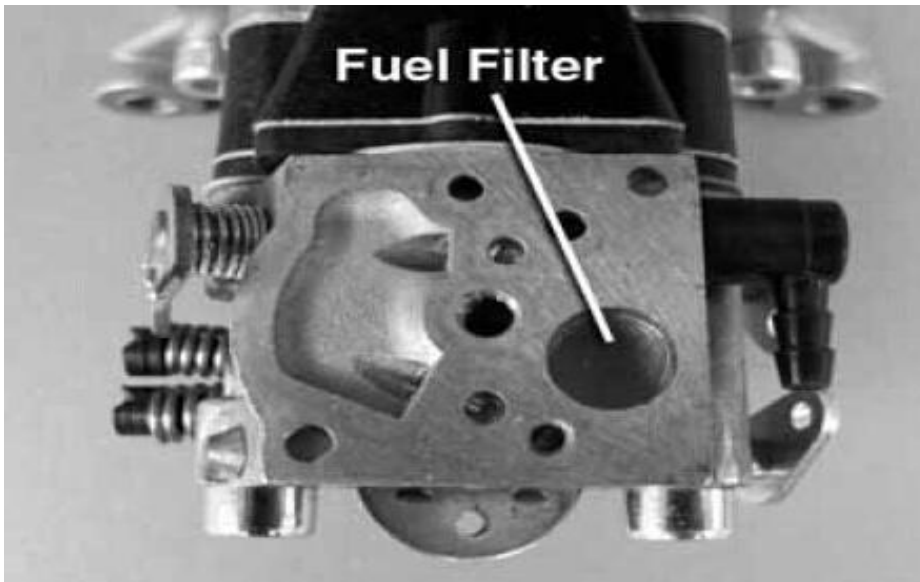
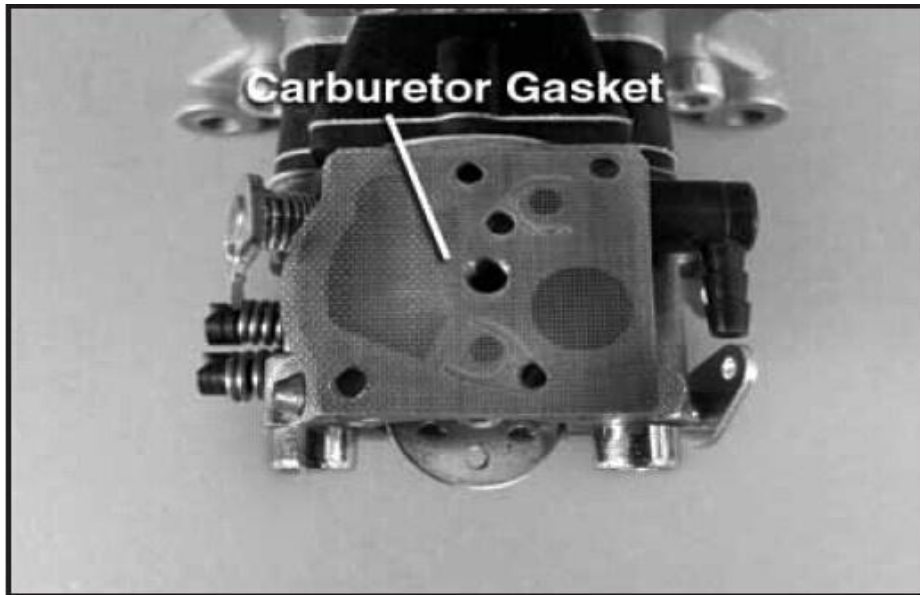

If you need carburetor spare parts please contact our service center on local.

Warranty Information

The RCGF-35RE has a two year limited warranty through RCGF service center beginning at the date of purchase. Please retain your receipt as your proof of purchase.

Contact Us

www.rcgfengine.com

www.rcgfservice.com

RCGF 35 cc RE

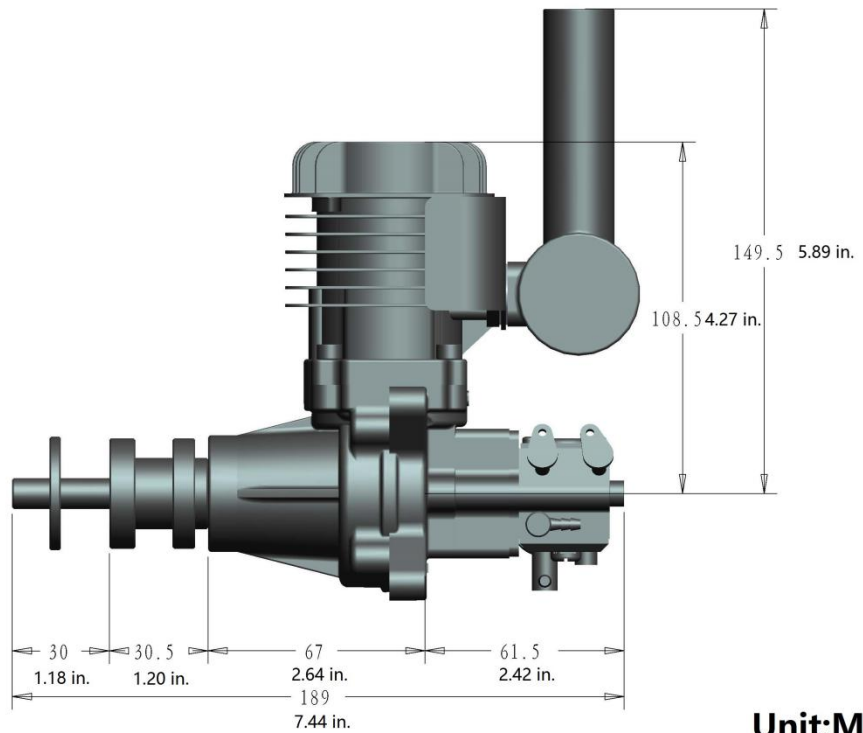

RCGF 35cc RE

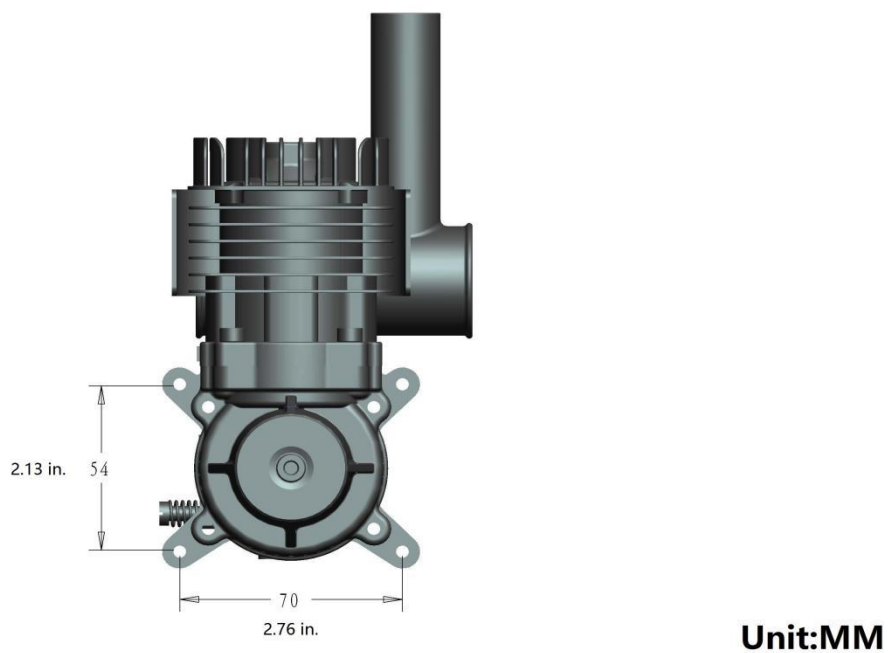

RCGF
RCGF 35cc RE



Item	Description	Accessory Number
1.	CYLINDER	3501
2.	CRANKSHAFTACCESSORY	3502
3.	CRANKCASE SET	3503
4.	PISTON ACCESSORY	3504+3505+3527+3528
5.	PROP HUB ACCESSORY	3524+3523+3516
6.	BEARINGS	3525, 3512
7.	IGNITION SET	3506
8.	WRIST PIN BEARING	3526
9.	REEDVALVE&INSULATOR	3511+3521
10.	CARBURETOR	3508
11.	SPARK PLUG	3510
12.	MUFFLER	3507
13.	GASKET SET	3519+3520+3518+3517
14.	SCREW SET	T9



RCGF 35cc

Parameter:

Type : 2 cycle piston valve type gasoline engine for airplane

Piston displacement Cylinder (cc) : 35cc (2.13 cu in)

Bore x Stroke (mm): 1.53 in(39mm) x 1.18 in (30mm)

Carburetor : RCGF

Ignition : DC-CDI (Computer Controlled auto advance, electronic ignition system)

Power supply: 4.8-8.4V

Maximum Output :4.1HP@9000

Requires: Gasoline, 2-cycle oil, ignition battery & propeller

speed rang : 1500-9000rpm

Gasoline-Version : Pre-mixed Fuel, 25-40 (Gasoline):1 , Recommend:30:1

(90% high octane unleaded gasoline, Import gas into carbon fiber installations valves)

Lubrication Oil : 2 cycle engine oil

Propeller : 19X8 7900rpm (Standard Two leafs prop)

Suggested Propellers: 19x8 & 20x8,20X10

Suggested Break-in Prop: 19x8

Sparking plug: NGK CM6 Type

Cooling System : Air Cooled