

Assembly Exploded Diagram

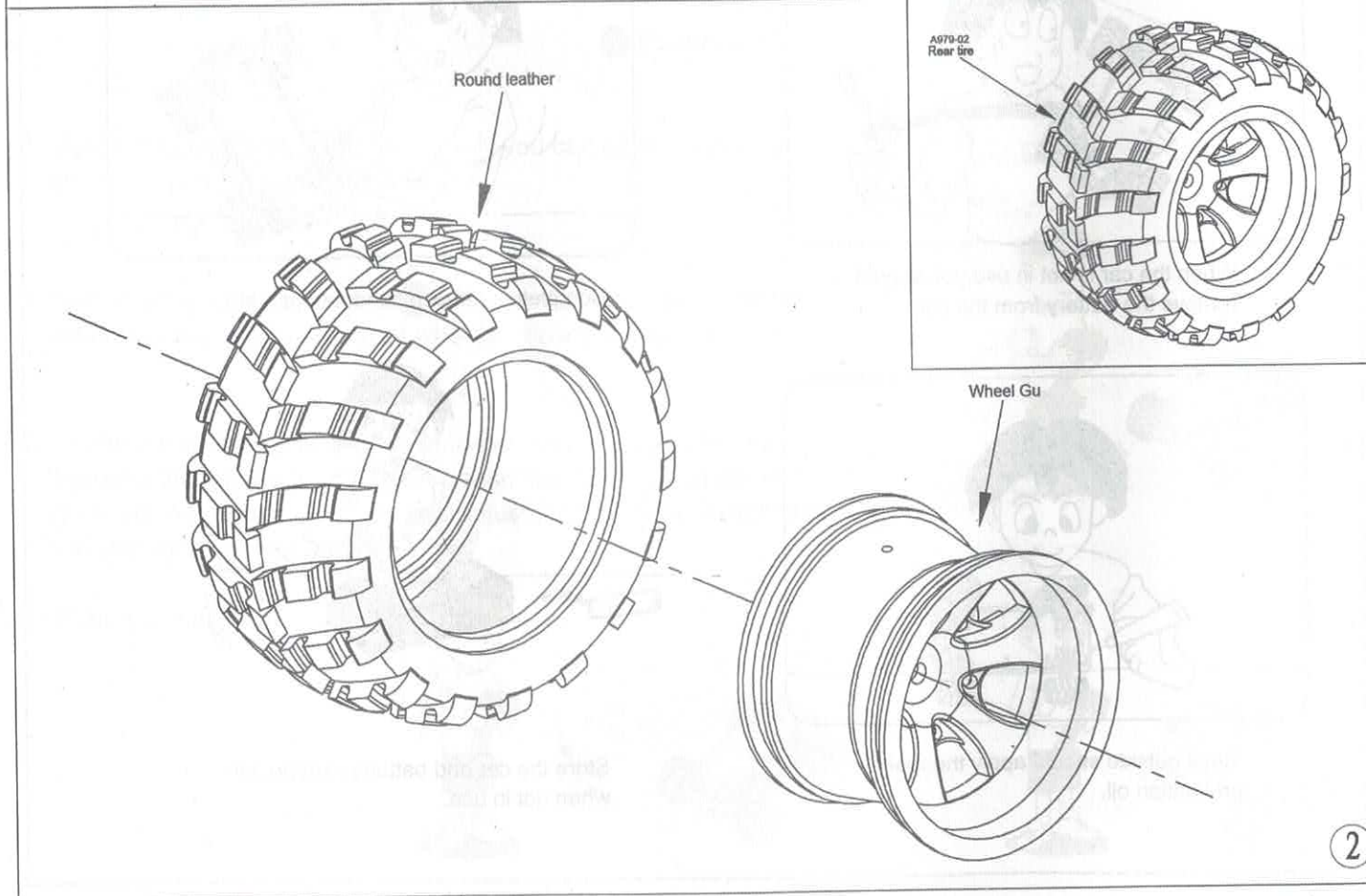

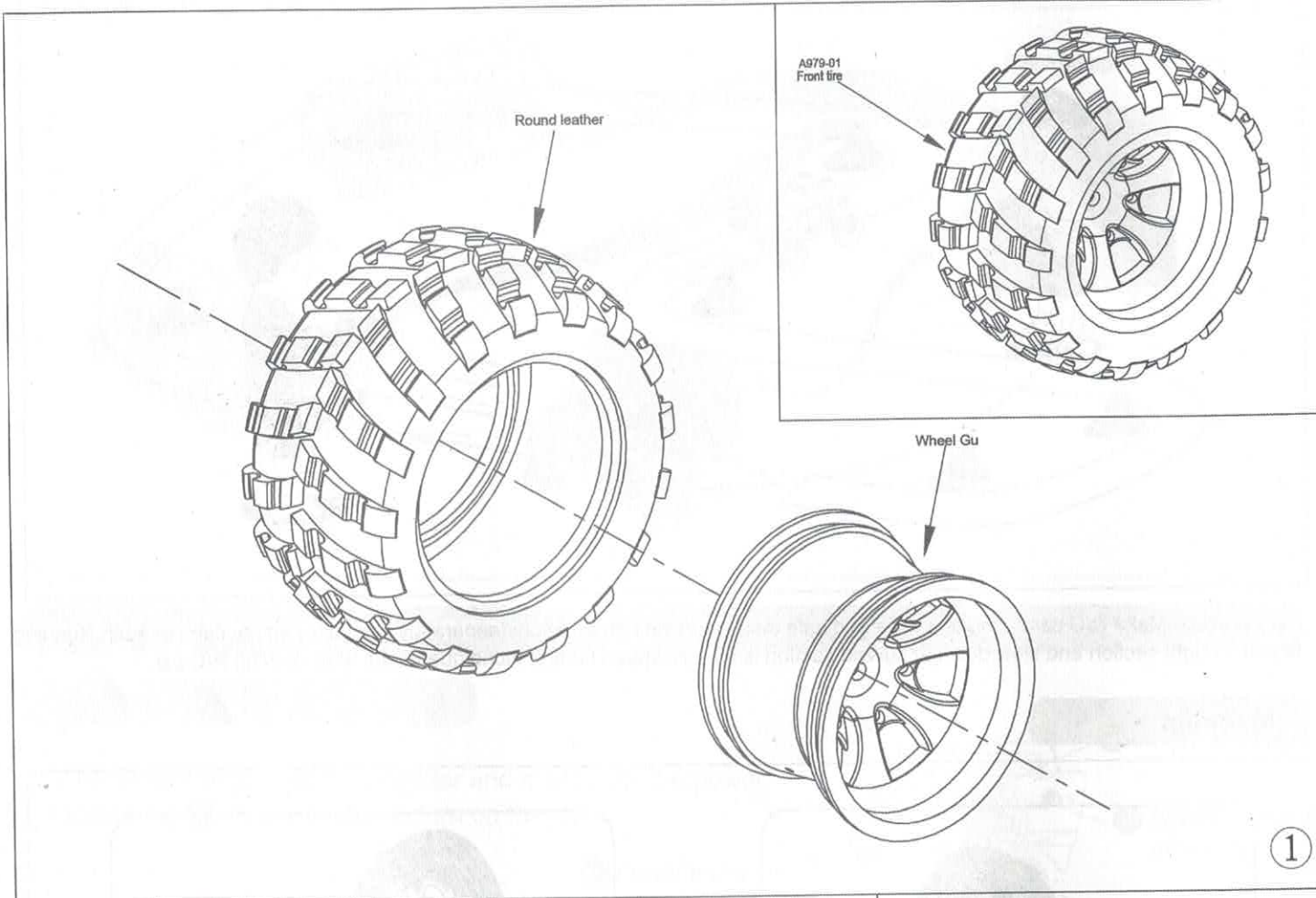

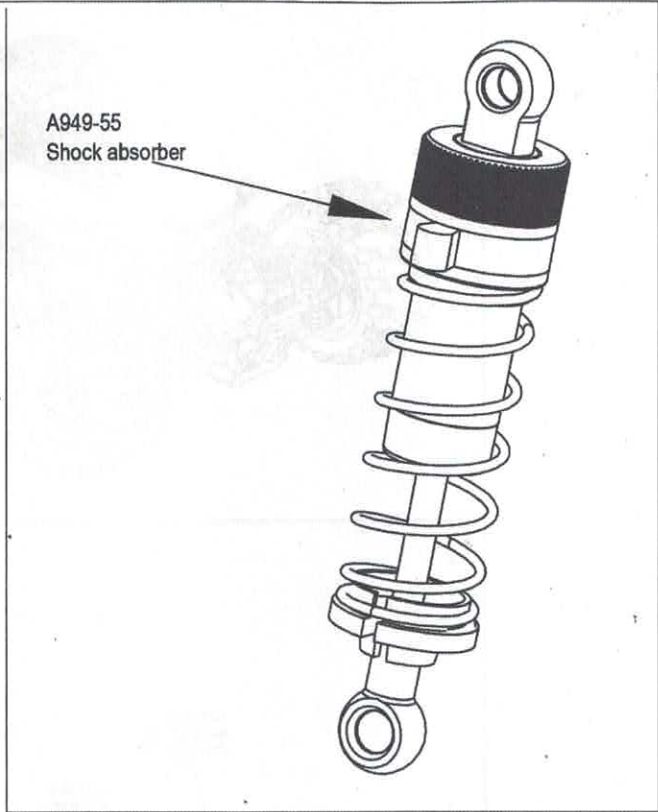

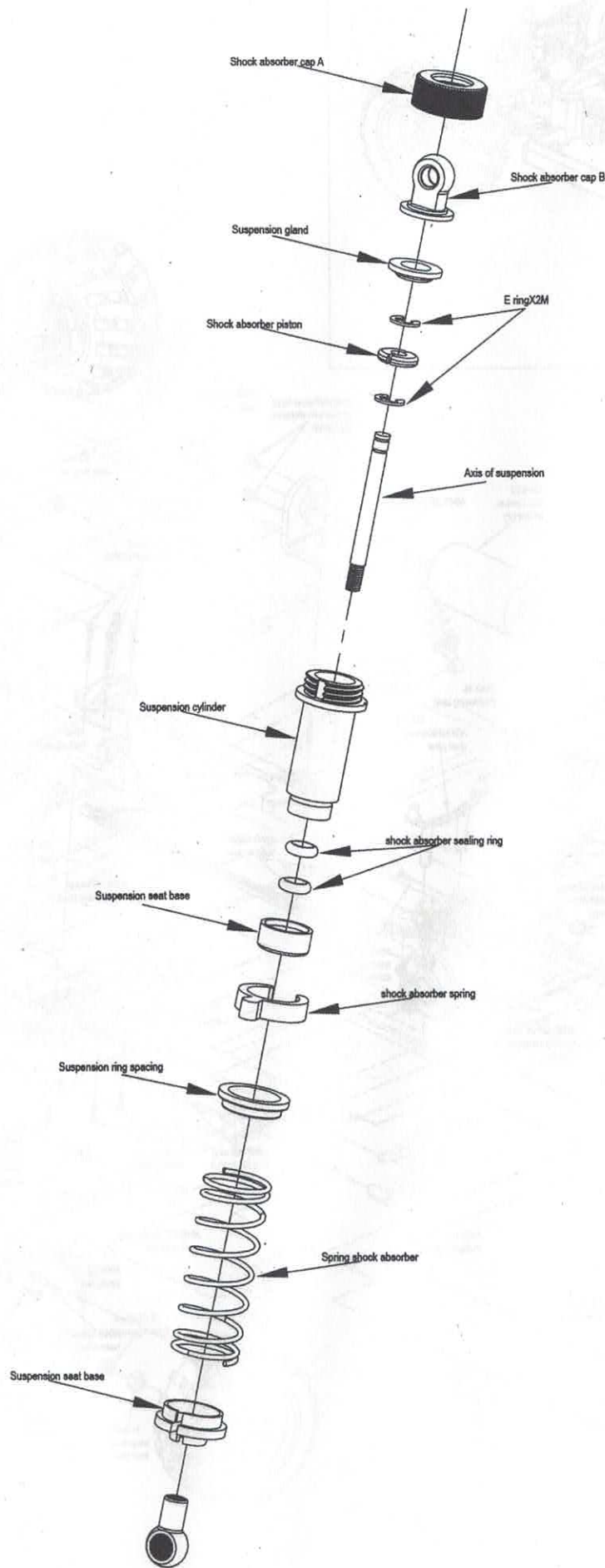
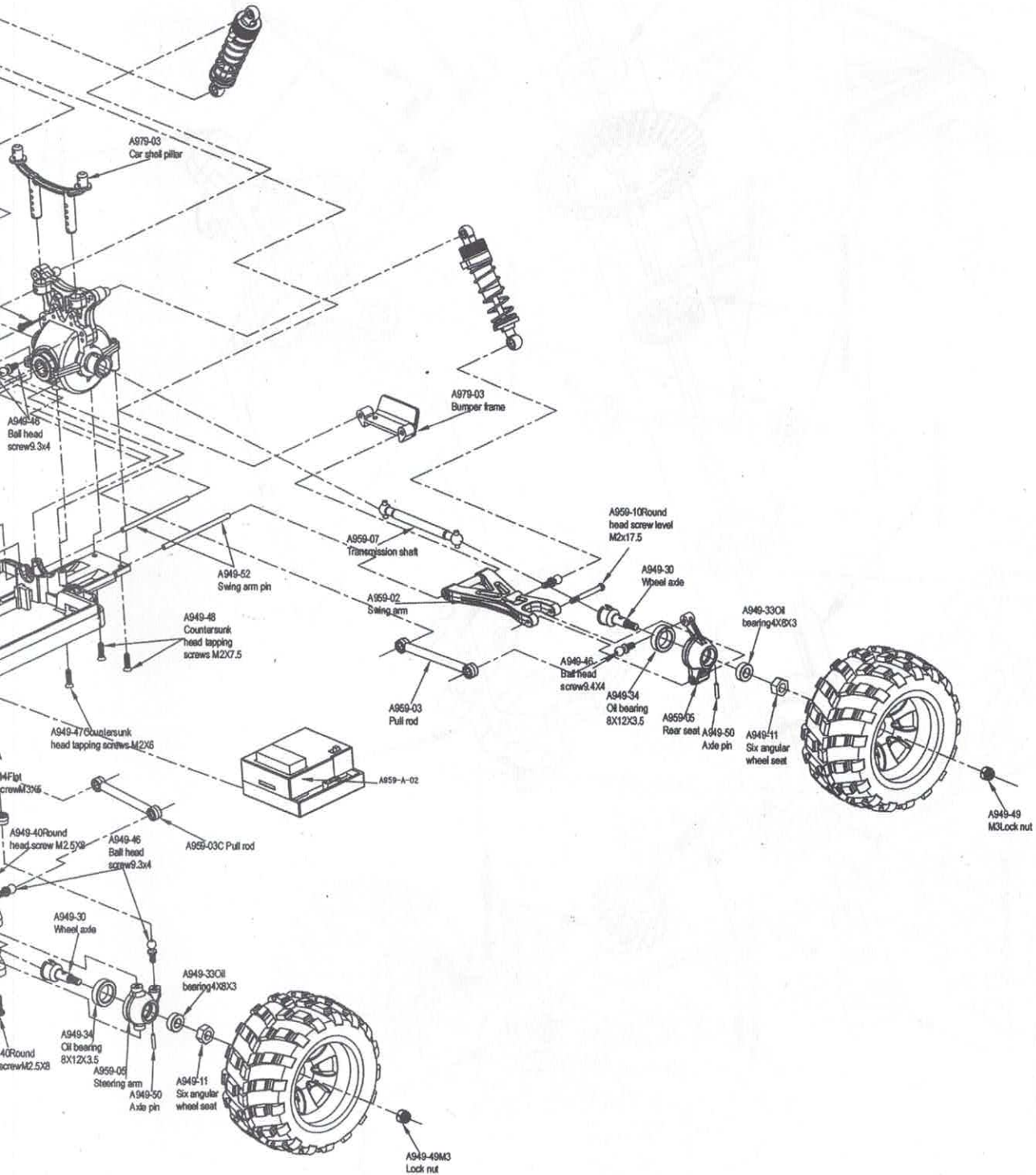
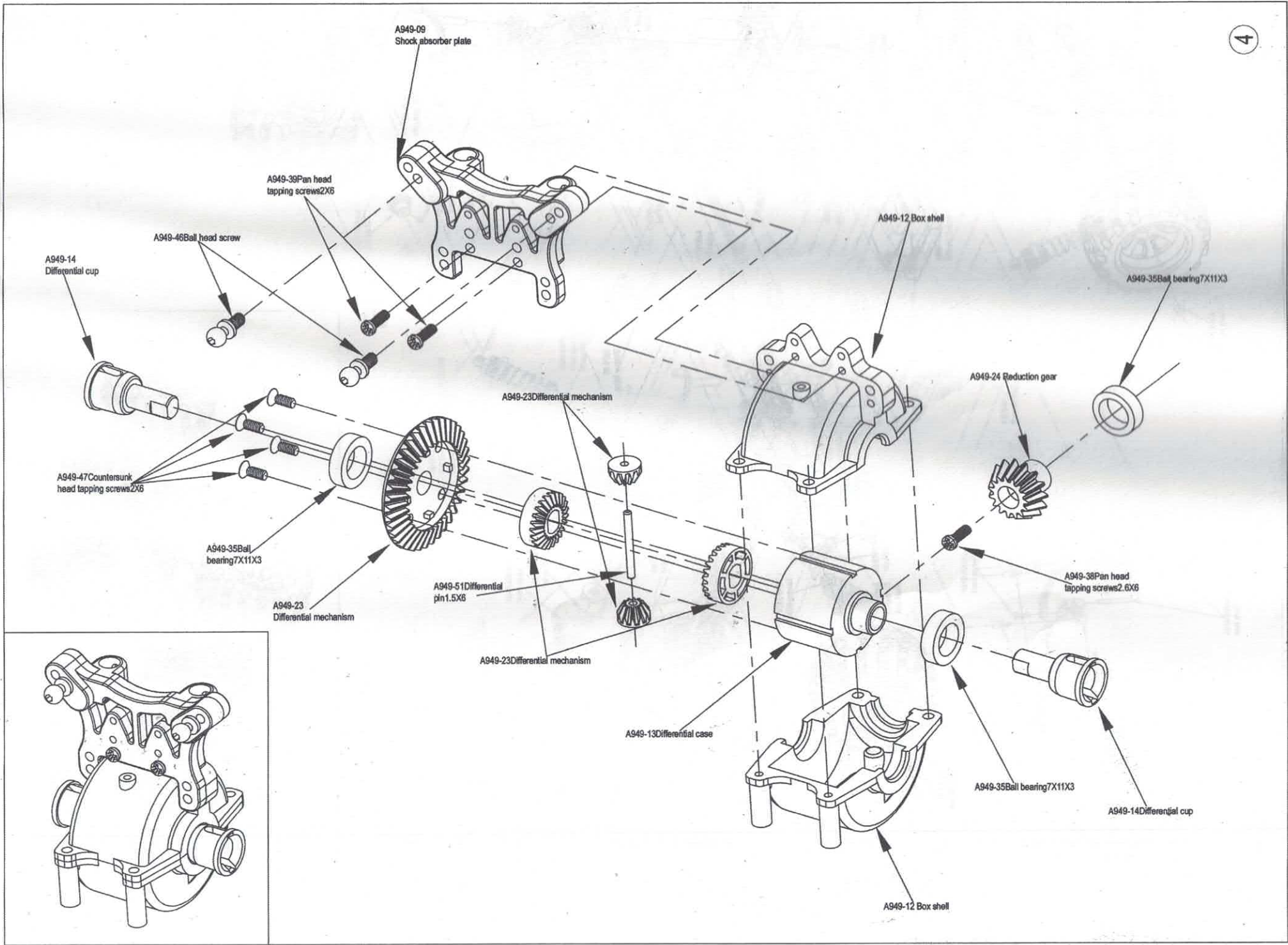

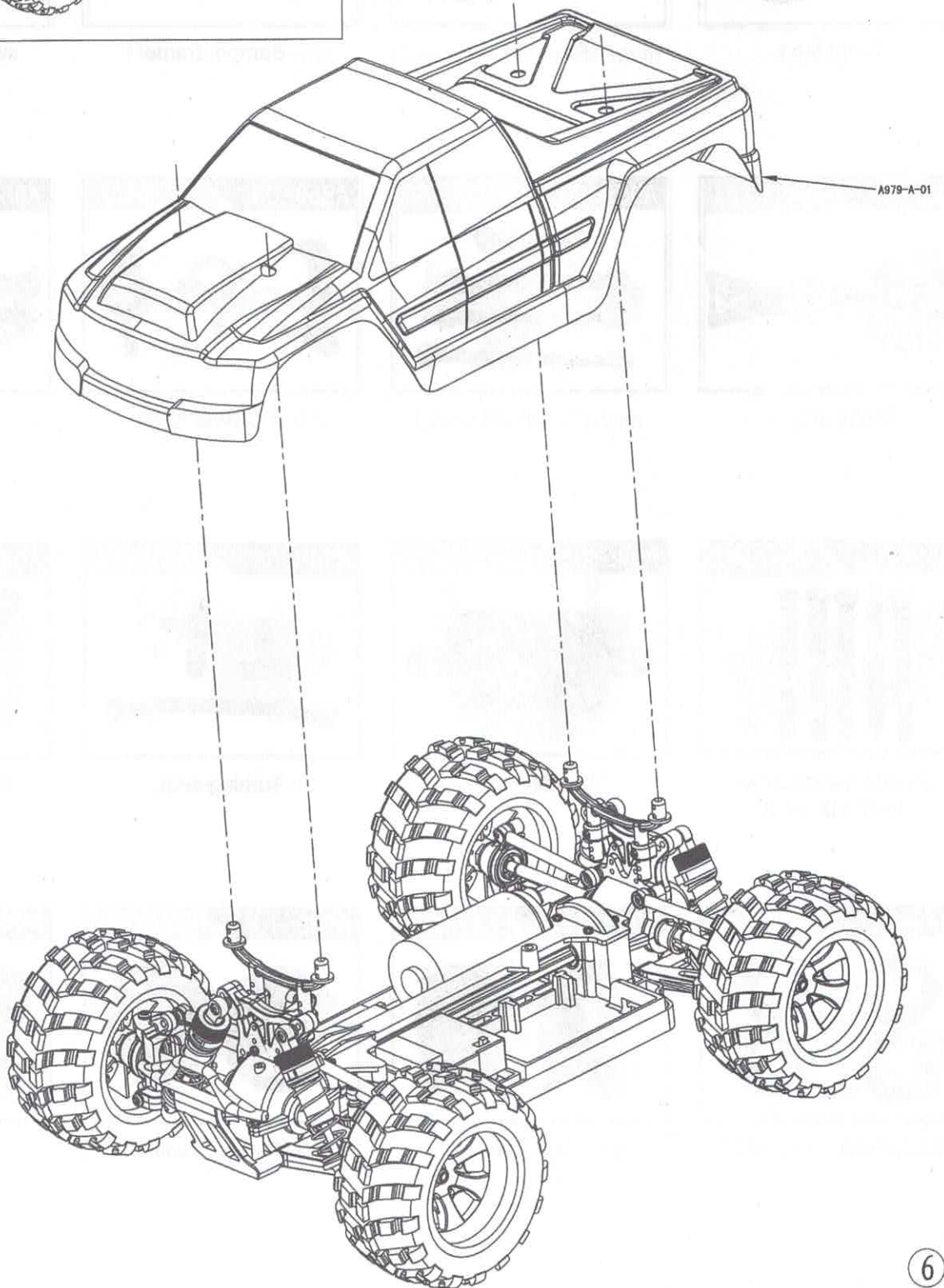
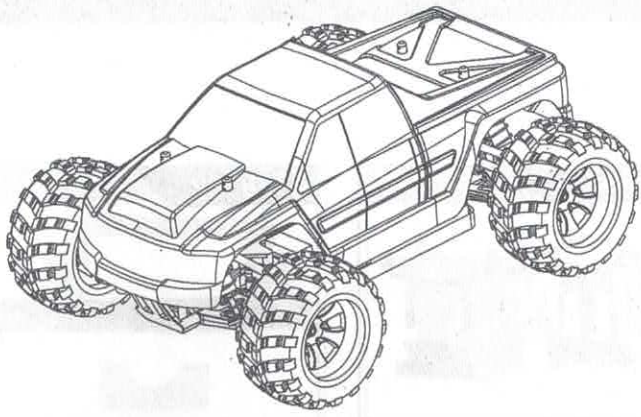

Sale parts view

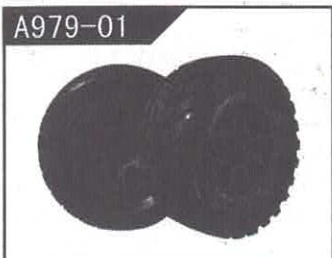

Front tire

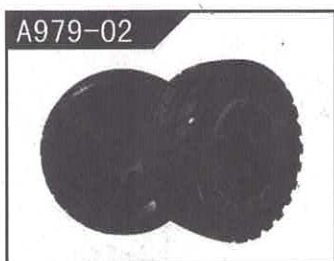

Rear tire

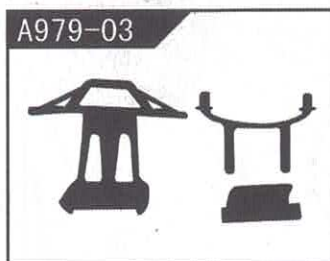

Bumper frame

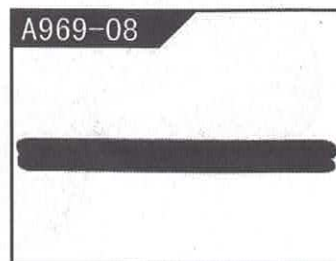

swing arm pin 2x40.8

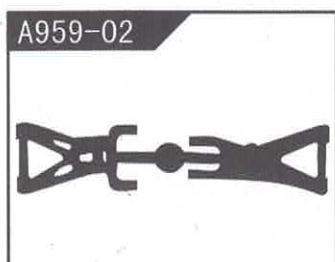

Swing arm

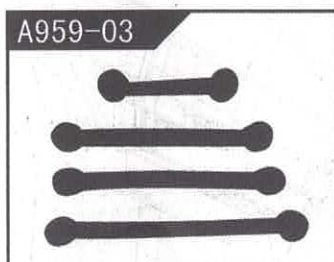

Pull rod

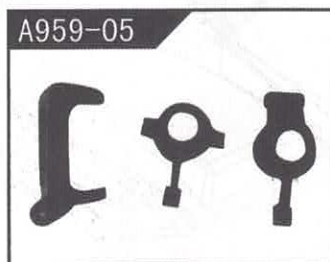

C Seat

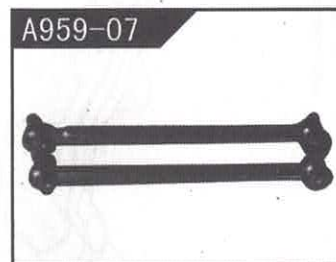

Transmission shaft 5.3x50.8

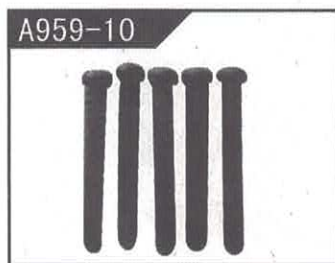

Round head screw level M2x17.5

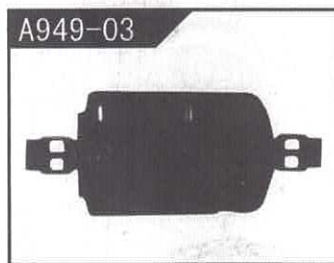

Underbody

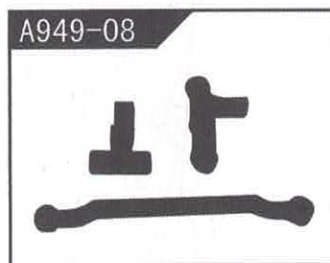

Turning seat

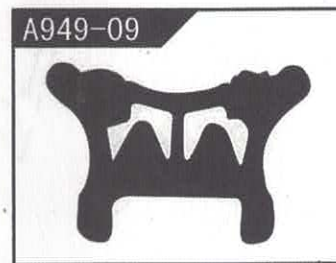

Shock absorber plate

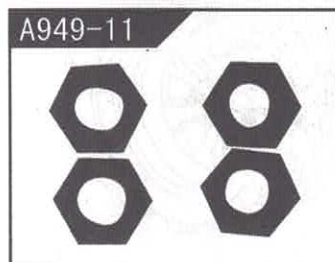

Six angular wheel seat

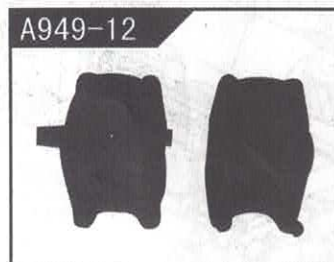

Box shell

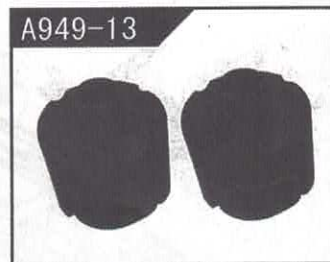

Differential case

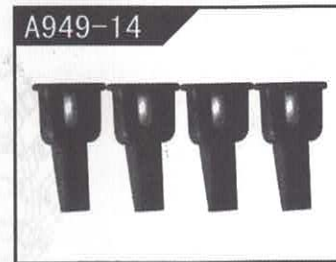

Differential cup

Sale parts view

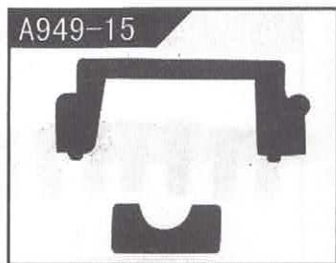

Positioning seat

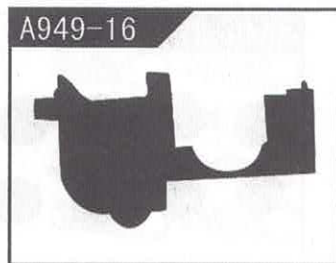

Motor dustproof seat

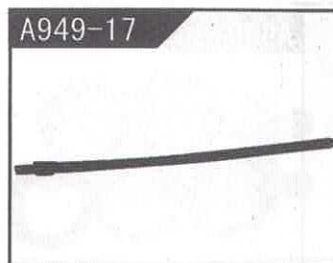

Central transmission shaft

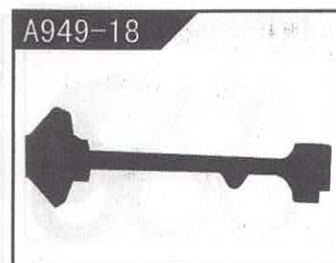

Two floor

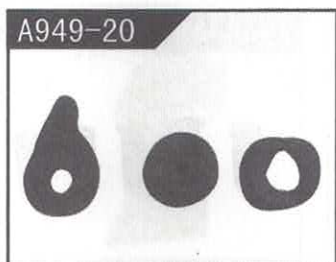

Servo arm

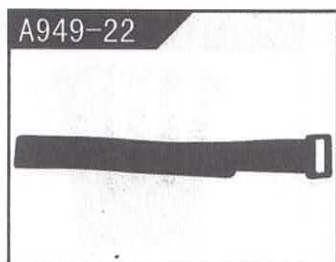

Magic stick 210MM

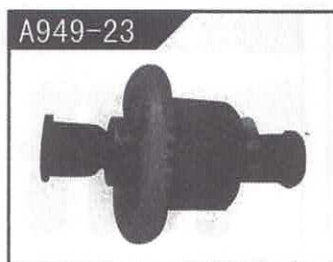

Differential mechanism

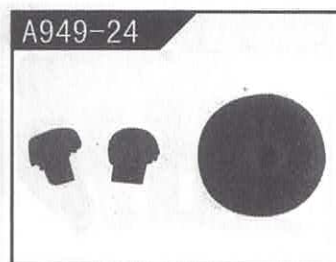

Reduction gear

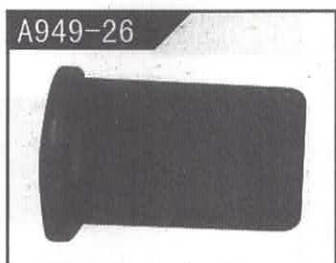

Motor seat

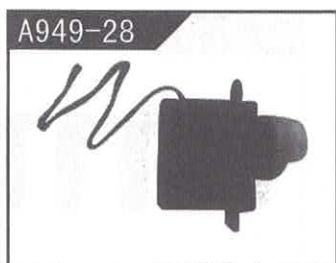

17g Steering gear

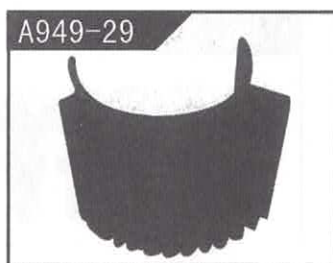

Motor heat dissipation cover

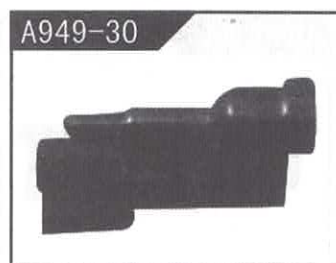

Wheel axle 9X22.1

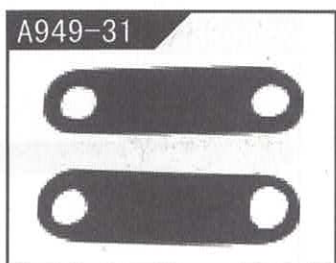

Motor is fixed seat
screw gasket

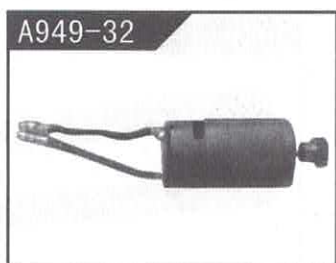

390 Electric machinery

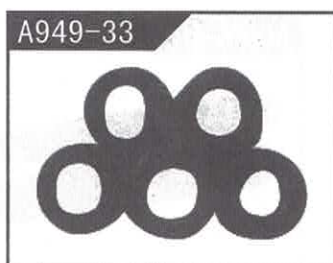

Oil bearing 4X8X3

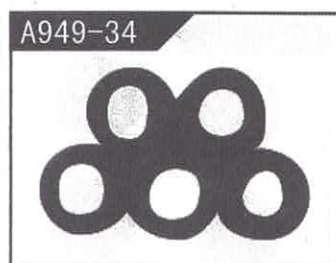

Oil bearing 8X12X3.5

Sale parts view

A949-35

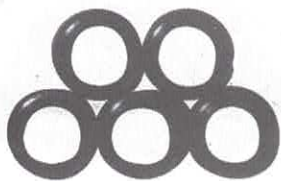

Ball bearing 7X11X3

A949-36

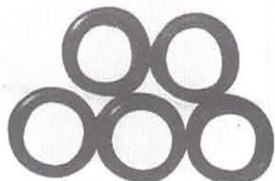

Ball bearing 8X12X3.5

A949-37

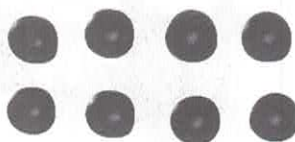

Swing arm 1X5

A949-38



Pan head tapping screws 2.6X6

A949-39



Pan head tapping screws 2X6

A949-40

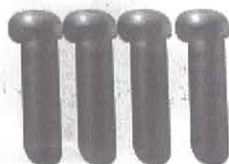

Round head screw M2.5X8

A949-41



Pan head tapping screws 2X16

A949-43



Round head screws with dielectric M2.5X6X6

A949-44



Flat head screw M3x5

A949-46

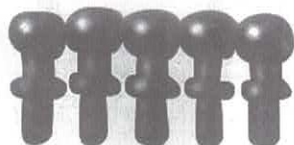

Ball head screw 10.8X4

A949-47

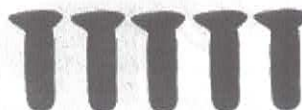

Countersunk head tapping screws 2X6

A949-48

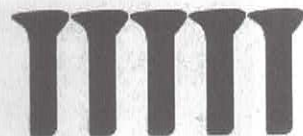

Countersunk head tapping screws 2X9.5

A949-49

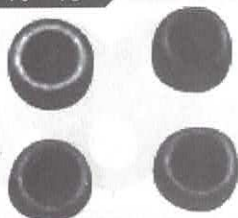

M3 Lock nut

A949-50

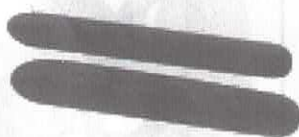

Axle pin 1.5X6.7

A949-51

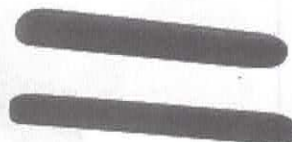

Differential pin 1.5X16

A949-52



Swing arm pin 2X37

Sale parts view

A949-53



Turning seat shaft 2X20.5

A949-54

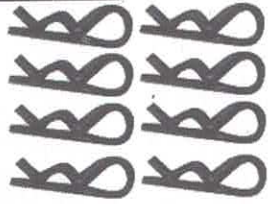

R Pin

A949-55

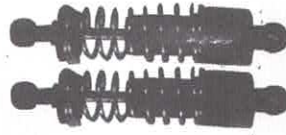

Shock absorber

K929-02



Hem arm reinforcement

959-A-01



2.4G remote control

A959-A-02

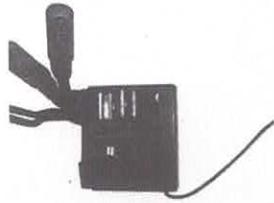

Triple electronic governor

959-A-03

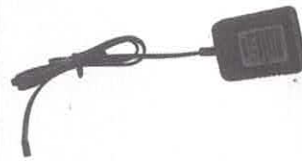

6.4V charger

A959-A-03

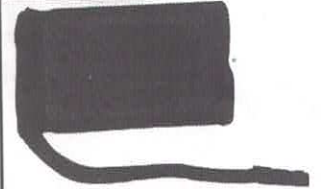

6.4V lithium battery

A979-A-01

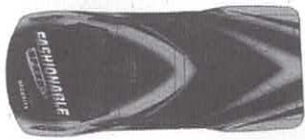

Car shell