

1

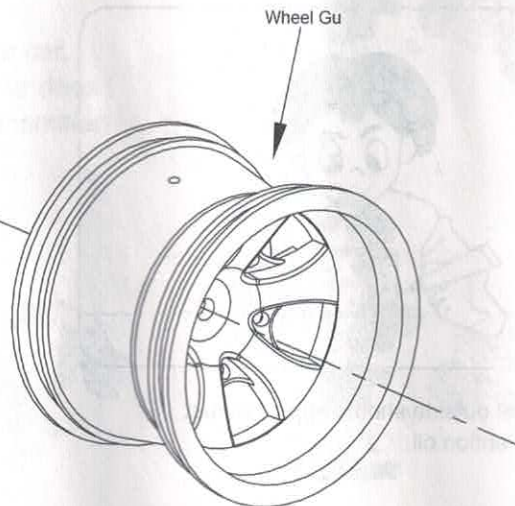

2

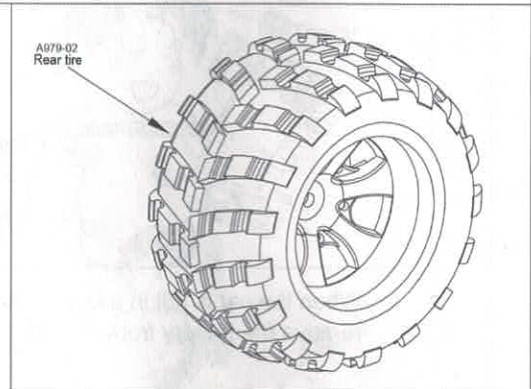

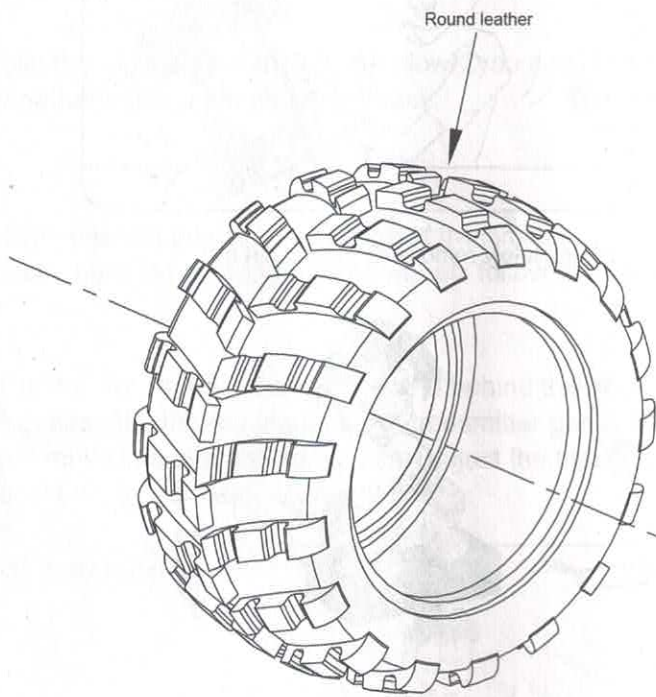
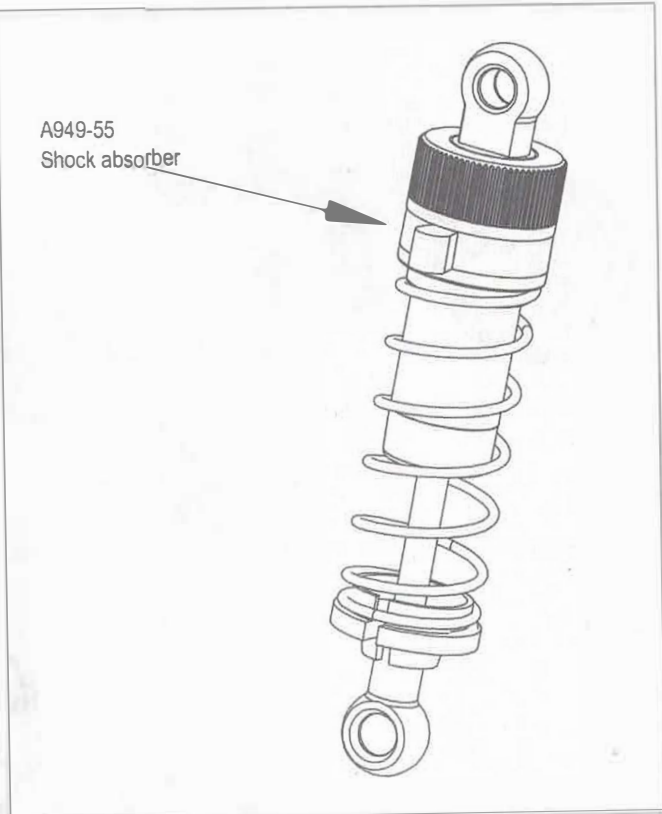
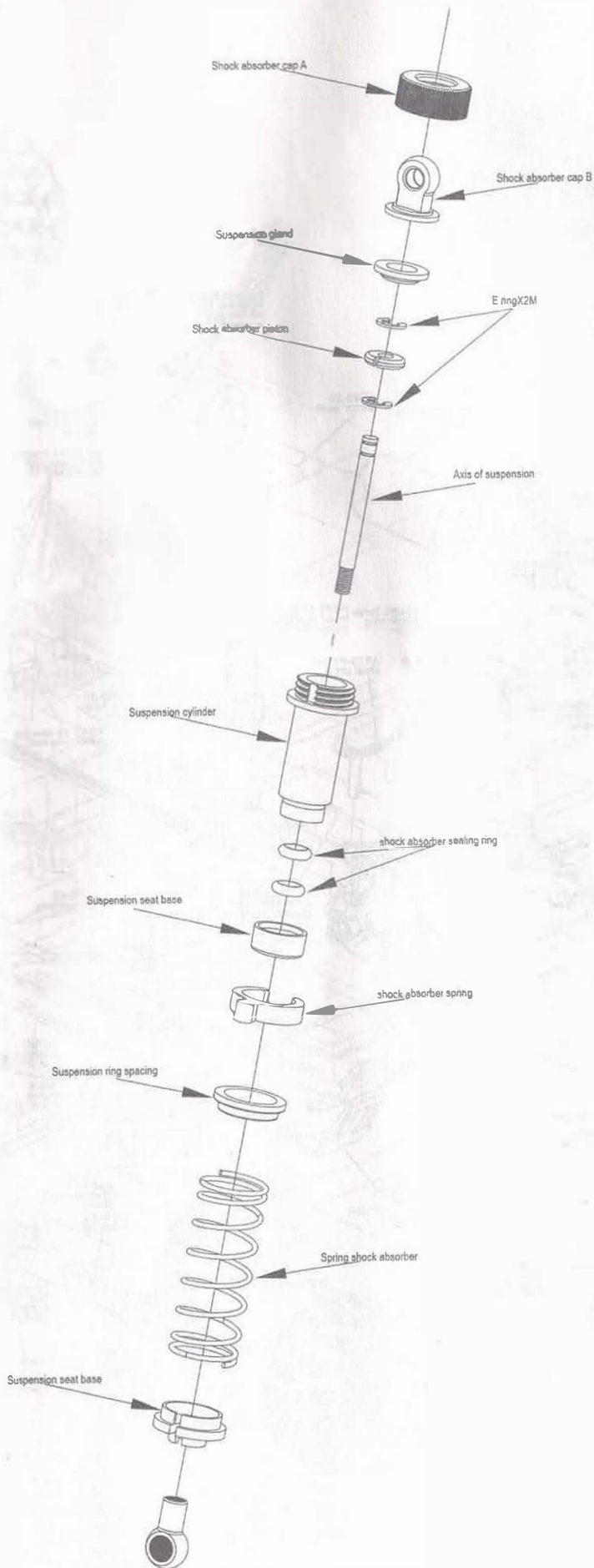
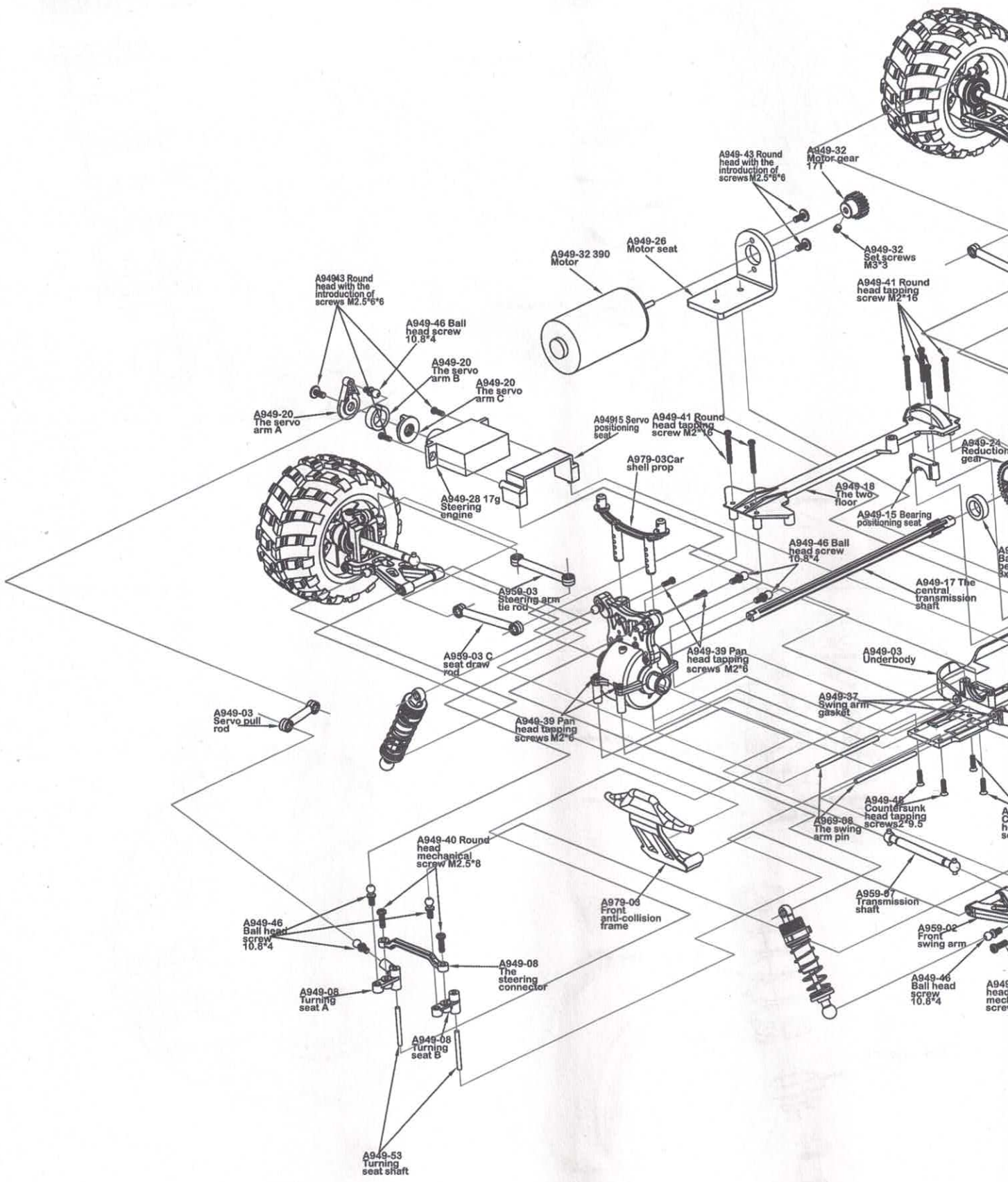

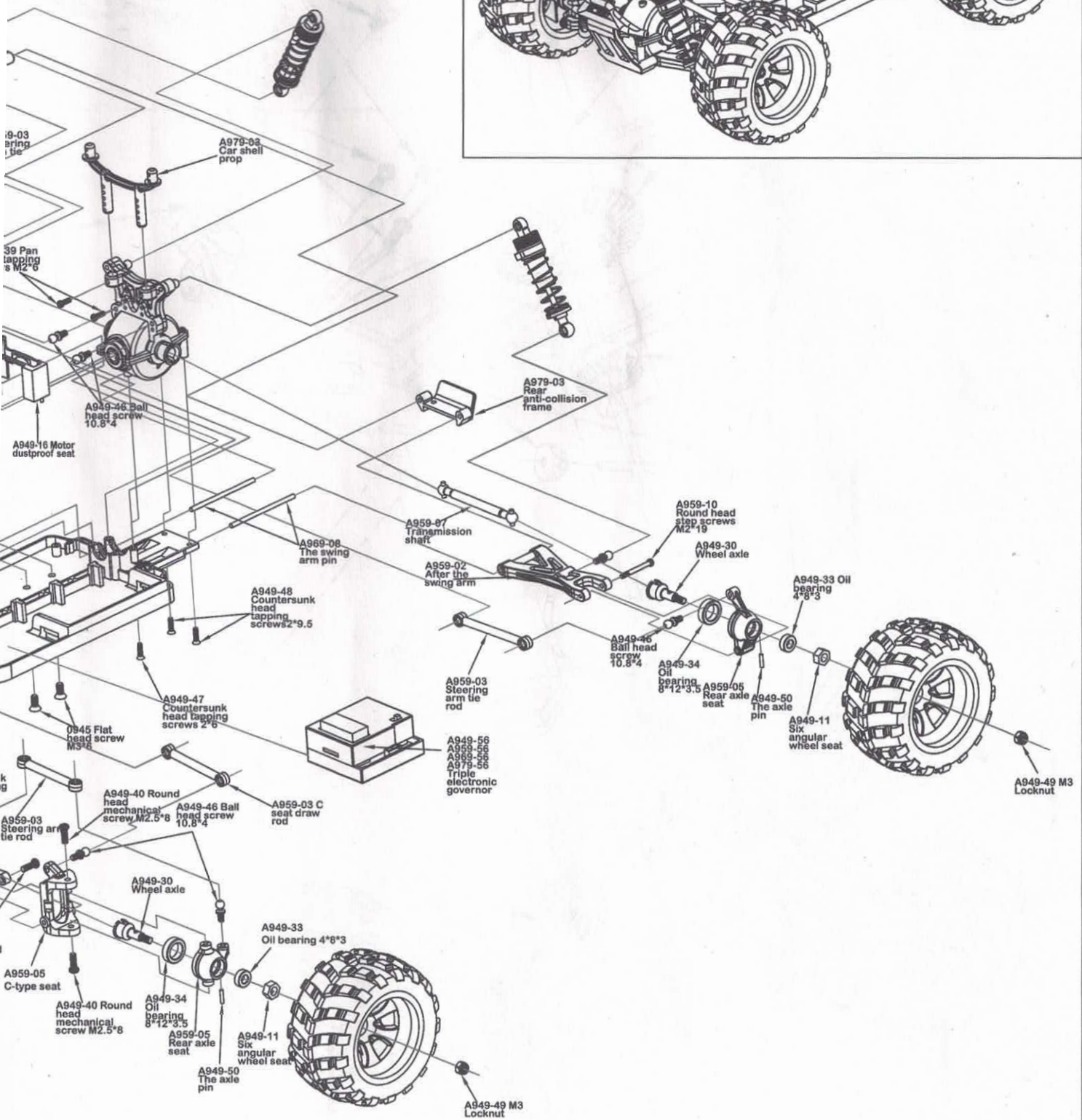
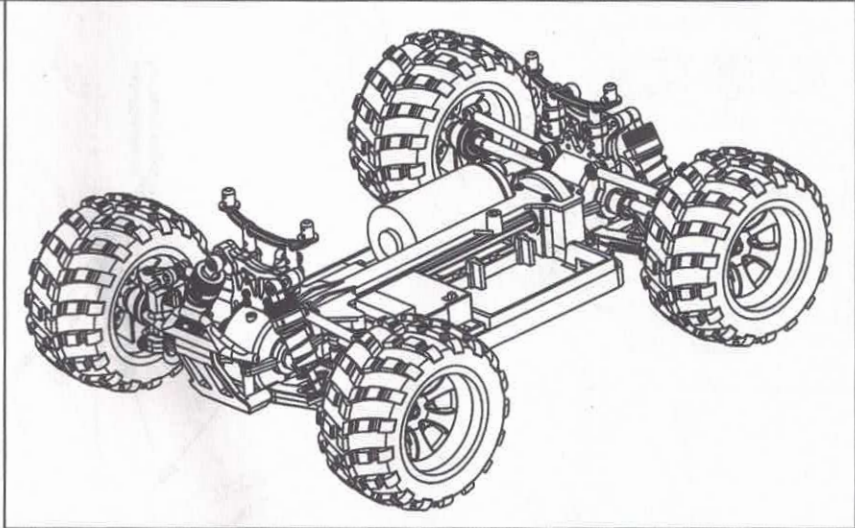

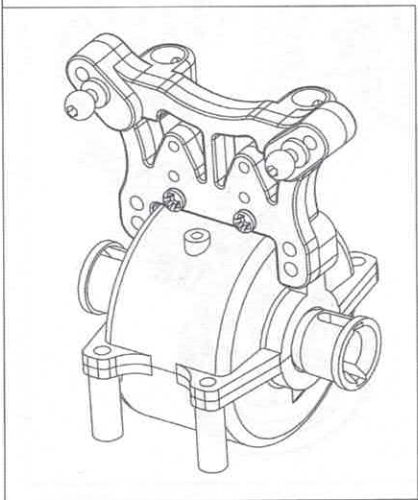
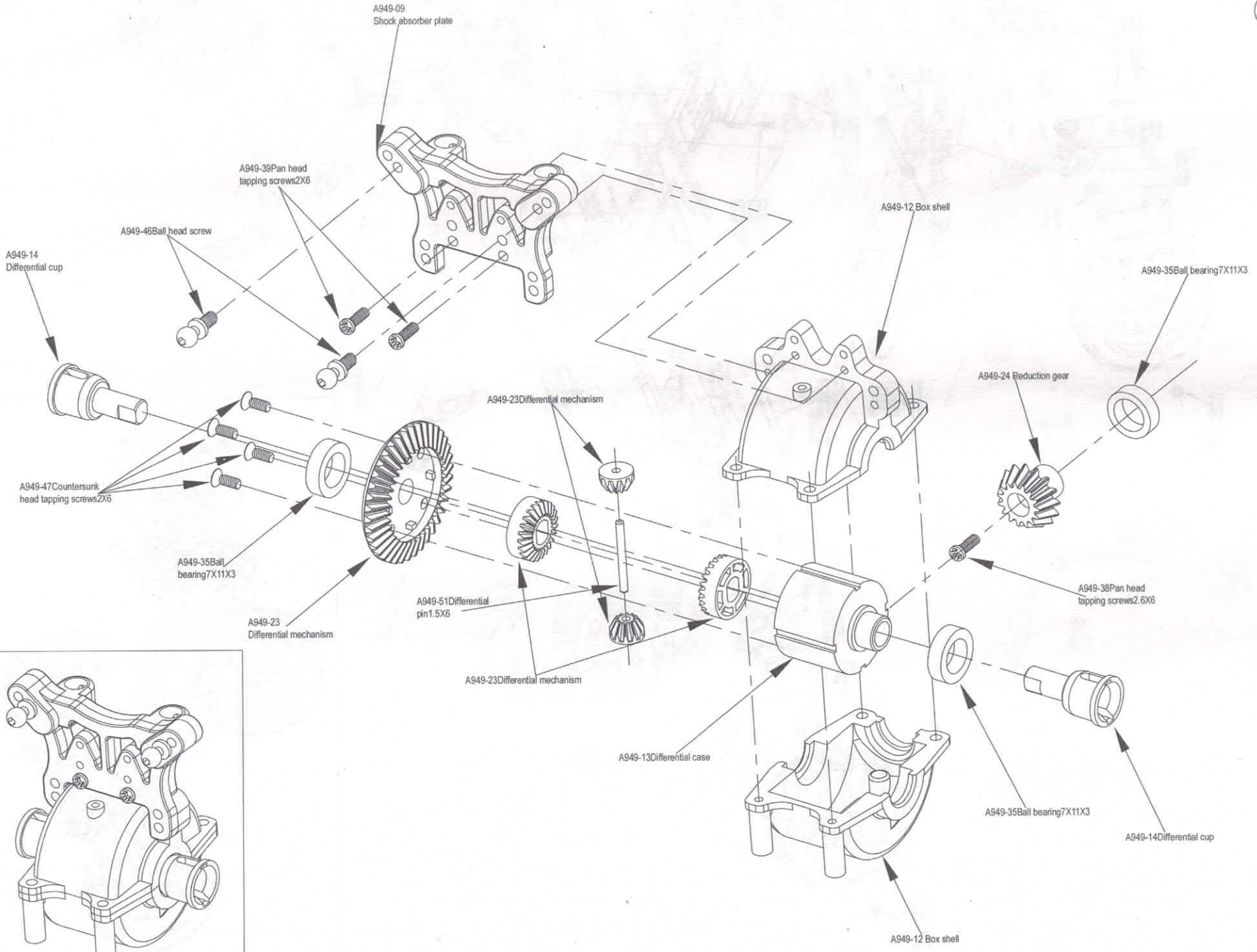

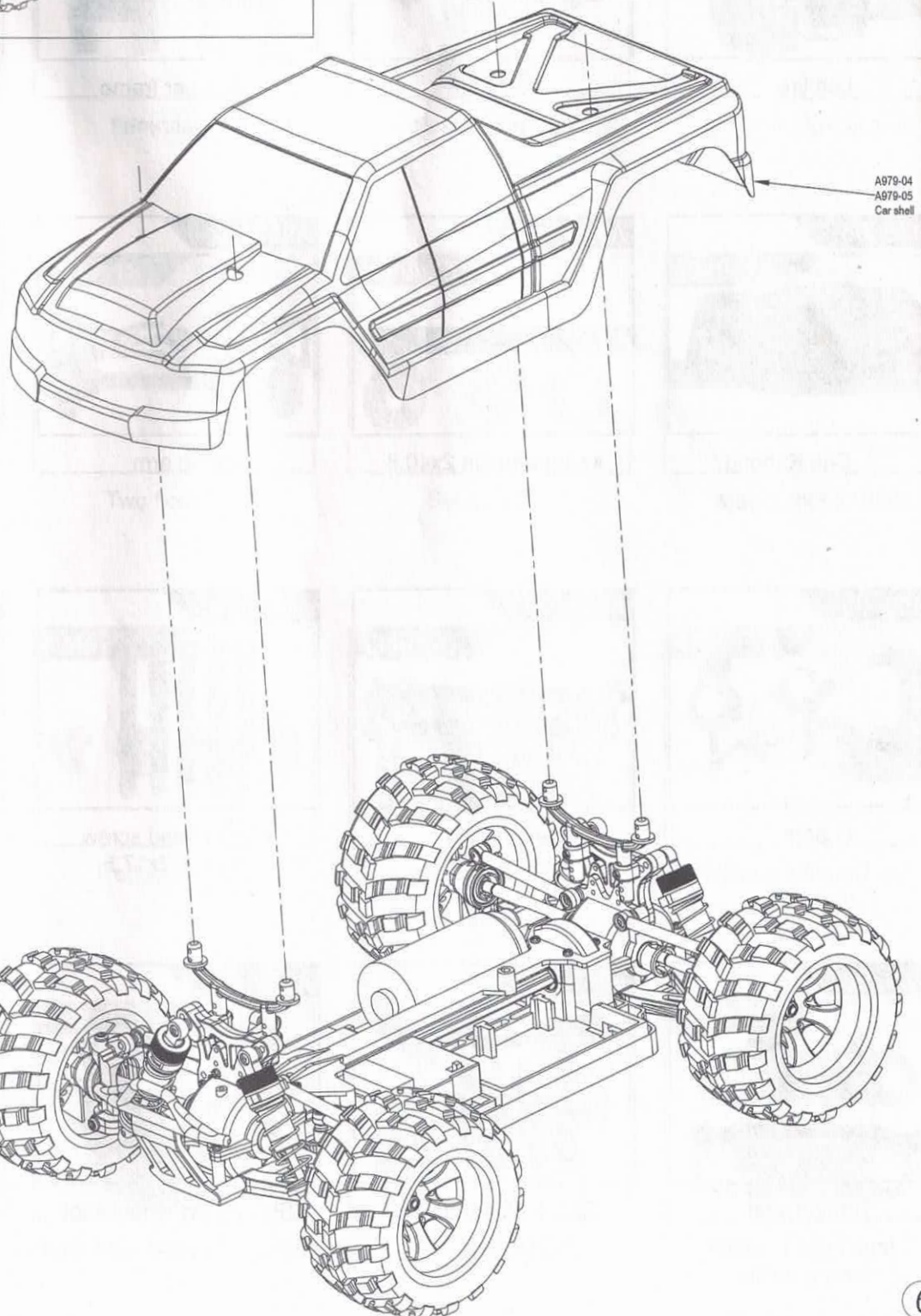
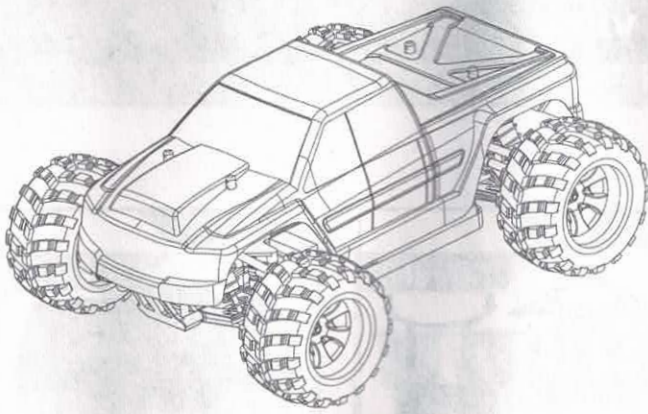

Sale parts view

A979-01



Left tire

A979-02



Right tire

A979-03



Bumper frame

A979-04



Car shell blue

A979-05



Che Kehong

A969-08



swing arm pin 2x40.8

A959-02



Swing arm

A959-03



Pull rod

A959-05

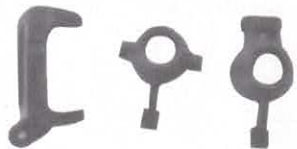

C Seat

A959-07



Transmission shaft 5.3x50.8

A959-10

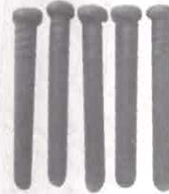

Round head screw level M2x17.5

A949-03

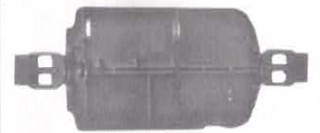

Underbody

A949-08



Turning seat

A949-09



Shock absorber plate

A949-11

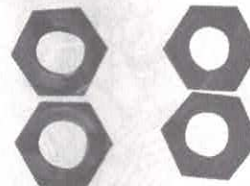

Six angular wheel seat

A949-12



Box shell

Sale parts view



Differential case

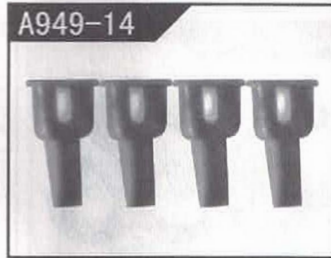

Differential cup

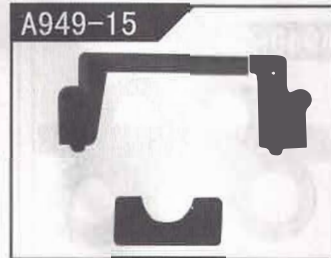

Positioning seat

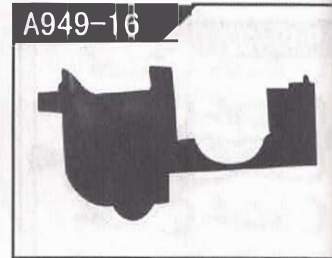

Motor dustproof seat

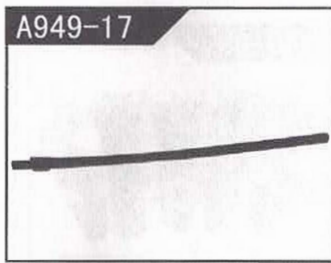

Central transmission shaft

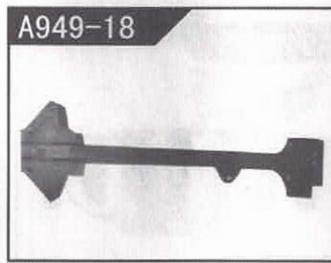

Two floor

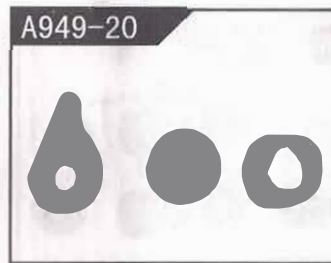

Servo arm

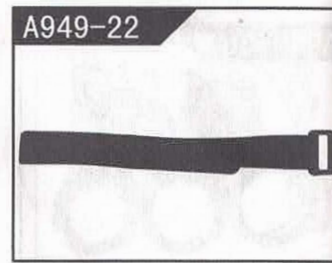

Magic stick 210MM



Differential mechanism

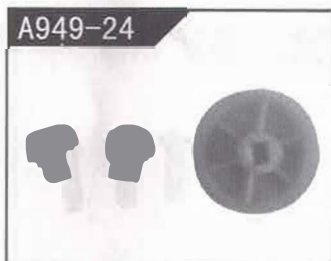

Reduction gear



Motor seat

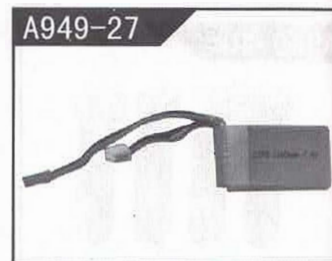

Lithium battery 7.4V
1100mah



16gSteering engine



Motor heat dissipation cover



Wheel axle 9X22.1



Motor is fixed seat
screw gasket

Sale parts view

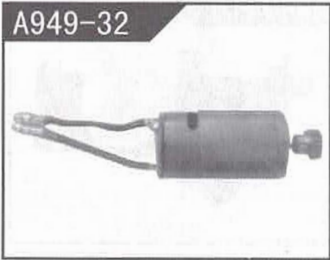

390 Electric machinery

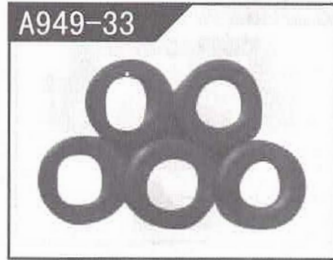

Oil bearing 4X8X3

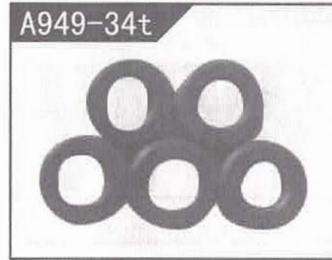

Oil bearing 8X12X3.5

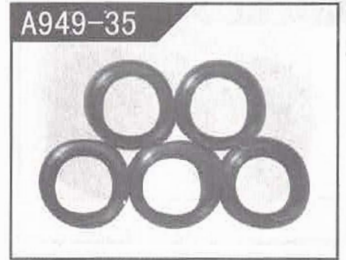

Ball bearing 7X11X3

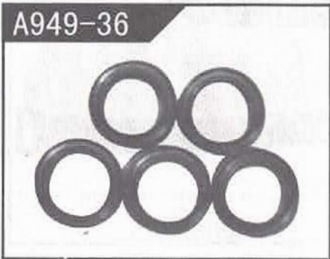

Ball bearing 8X12X3.5t

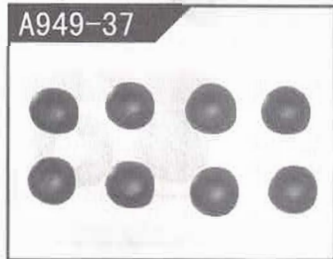

Swing arm 1X5

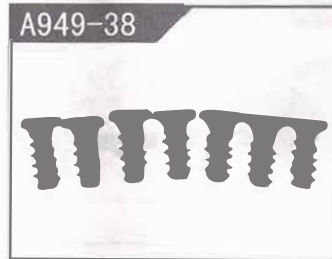

Pan head tapping screws 2.6X6



Pan head tapping screws 2X6



Round head screw M2.5X8



Pan head tapping screws 2*16

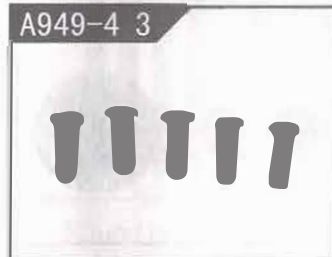

Round head screws with dielectric M2.5X6X6



Flat head screw M3x5

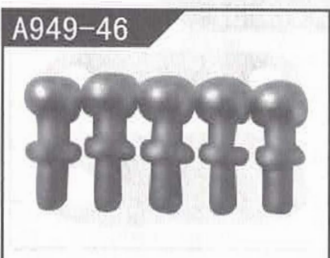

Ball head screw 10.8x4

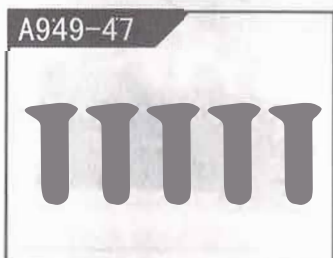

Countersunk head tapping screws 2X6

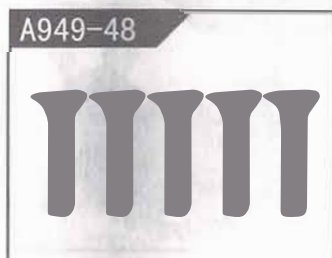

Countersunk head tapping screws 2X7.5

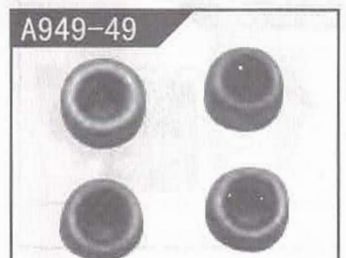

M3 Lock nut

Sale parts view

A949-50

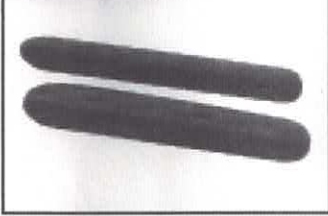

Axle pin1.5X7

A949-51

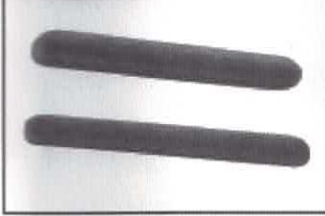

Differential pin1.5X16

A949-53

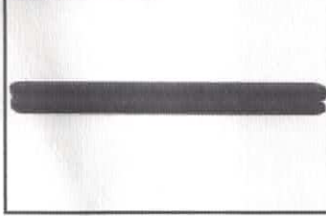

Turning seat shaft2X20.5

A949-54

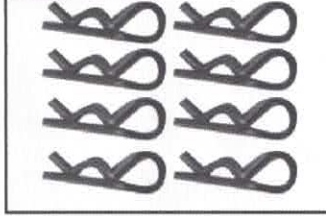

R Pin

A949-55

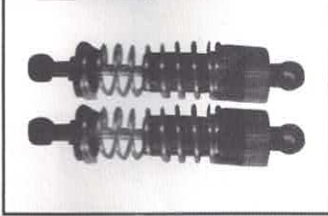

Shock absorber

A949-56

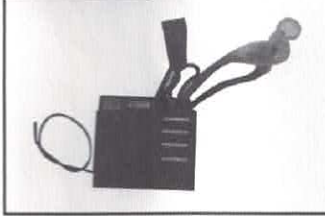

Receiver

A949-57

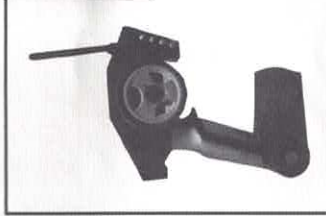

2.4GRemote control

A949-58



Charger